

AEC Media Feed Version 4.3

User Guide

Document Version 4.3, August 2023

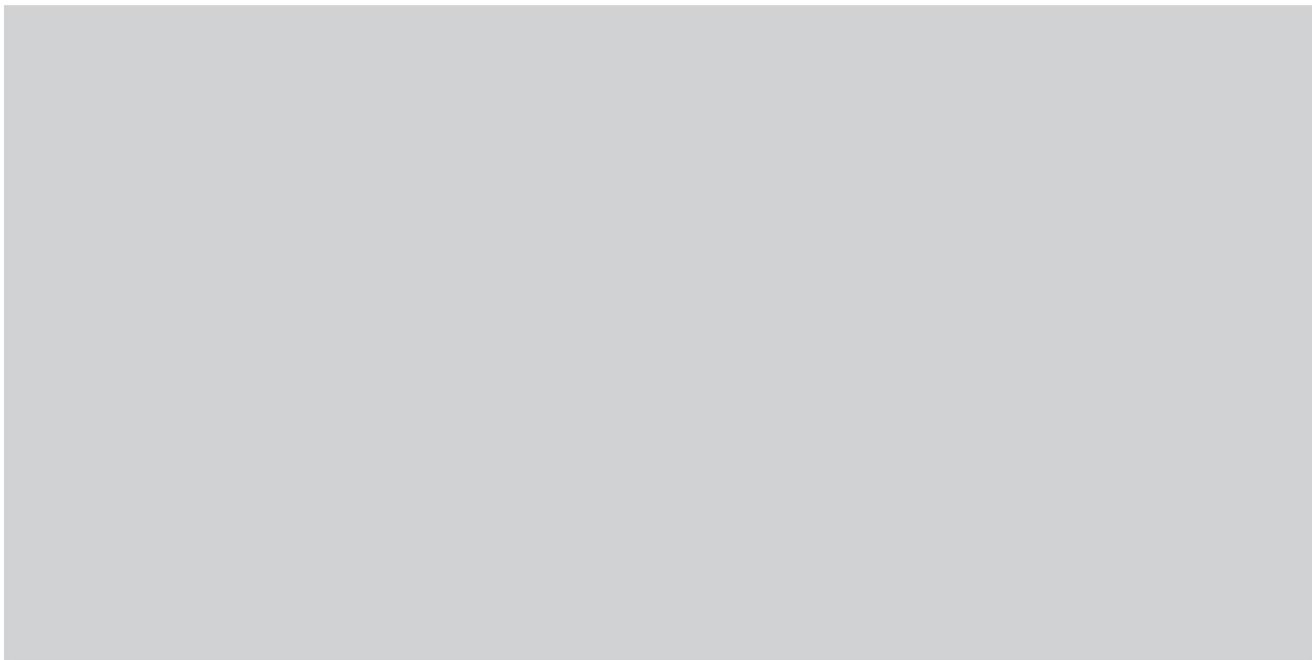

AEC

Australian Electoral Commission

Document Control

Version	Release Date	Author	Reason
3.1	9/4/2013	IT Solutions	Updated post 2010 election
4.0	23/01/2019	IT Solutions	Updated post 2016 election
4.1	04/06/2020	IT Solutions	Updated post 2019 election
4.2	17/02/2022	IT Solutions	Updated pre 2022 election
4.3	08/2023	IT Solutions	Updated pre 2023 referendum

Acceptance and Release Notice

This is a managed document. All copies of this document preceding this release are obsolete and shall be destroyed.

Release Status

Version Number	Date	Reason for Release	Review No.
3.1	9/4/2013	Updated to new AEC style template	
4.0	23/01/2019	Updated URL's and various style updates.	
4.1	04/06/2020	Minor discrepancy updates.	
4.2	17/02/2022	Minor updates	

Contents

1. Introduction	7
1.1 Audience	7
1.2 Scope	7
1.3 Related Documents	7
2. System Overview	8
2.1 System Diagram	9
3. Accessing the Media Feed System	10
3.1 System Requirements	10
3.1.1 Internet Access	10
3.1.2 FTP Client Software.....	10
3.1.3 Authentication	10
3.1.4 Compression software that supports the ZIP technology	11
3.1.5 XML Parser or Transformation Engine	11
3.2 Message Types	11
3.2.1 Granularity	11
3.2.2 Verbosity.....	11
3.3 Media Feed FTP Site.....	12
3.3.1 URL	12
3.3.2 Archive.....	12
3.3.3 Folder Structure	12
3.4 Cycle Times.....	13
3.5 Recommended Feed Usage	13
3.5.1 Feed Granularity	13
3.5.2 Feed Verbosity.....	14
3.5.3 Examples.....	14
4. Feeds	16
4.1 Compression	16
4.2 Media feed file naming convention	16
4.3 Feed Granularity.....	16

4.4	Standard Granularity Feeds.....	17
4.4.1	Preload Feed	17
4.4.2	Verbose Feed	17
4.4.3	Light Feed.....	18
4.4.4	Election Markup Language (EML) Feed.....	18
4.5	Detailed Granularity Feeds	18
4.5.1	Preload Feed	19
4.5.2	Verbose Feed	19
4.5.3	Light Feed.....	19
4.5.4	Light Progress Feed.....	20
5.	Media Feed Messages	21
5.1	Message file naming convention.....	21
5.1.1	EML Messages	21
5.1.2	AEC Messages	22
5.2	White space and Formatting	22
5.3	Schema Documentation	22
5.3.1	Election Mark-up Language (EML).....	22
5.3.2	AEC Media Feed Message Schema	22
5.4	Understanding the XML schema.....	23
5.4.1	XML Software Engineering Tools.....	23
5.4.2	Reading schema diagrams in this document.....	23
6.	Preload Messages.....	25
6.1	Preload Results Message.....	25
6.1.1	Overview.....	25
6.1.2	Message Schema	25
6.1.3	Example XML	25
6.1.4	Estimated Message Size	27
6.2	Election Event Message (EML 110).....	27
6.2.1	Overview.....	27
6.2.2	Message Schema	27
6.2.3	Example XML	30

6.2.4	Estimated Message Size	31
6.3	Candidate List Message (EML 230).....	31
6.3.1	Overview.....	31
6.3.2	Message Schema	32
6.3.3	Example XML	34
6.3.4	Estimated Message Size	35
6.4	Referendum Options List Message (EML 630)	35
6.4.1	Overview.....	35
6.4.2	Message Schema	35
6.4.3	Example XML	36
6.4.4	Message Size	37
6.5	Polling Districts Message.....	37
6.5.1	Message Schema	38
6.5.2	Example XML	40
6.5.3	Estimated Message Size	41
6.6	Senate Group Voting Tickets Message.....	41
6.6.1	Message Schema	41
6.6.2	Example XML	42
6.6.3	Estimated Message Size	44
6.7	Ballot Paper Message	44
6.7.1	Message Schema	45
6.7.2	Example XML	45
6.7.3	Estimated Message Size	46
7.	Results Messages.....	47
7.1	AEC Results Message.....	47
7.1.1	Overview.....	47
7.1.2	Message Granularity.....	47
7.1.3	Message Verbosity	48
7.1.4	Schema	50
7.1.5	Example XML	59
7.1.6	Estimated Message Size	61

7.2	EML Count Message (EML 510).....	62
7.2.1	Overview.....	62
7.2.2	Message Schema	63
7.2.3	Example XML	64
7.2.4	Estimated Message Size	66
7.3	EML Result Message (EML 520).....	66
7.3.1	Overview.....	66
7.3.2	Message Schema	67
7.3.3	Example XML	67
7.3.4	Estimated Message Size	69
8.	What's new in Version 3.0?	70
8.1	Introduction.....	70
8.2	Election Mark-up Language (EML) Version 5.0	70
8.3	XML Schema Files	70
8.4	Polling place classification for pre-poll voting centres	70
8.4.1	Message Schema Changes	70
8.4.2	Example XML	71
8.5	Media Feed Element (File Header).....	71
8.5.1	Message Schema Changes	71
8.5.2	Example XML	72
8.6	Count Message (EML message 510).....	73
8.6.1	Message Schema Changes	73
8.6.2	Example XML	73
8.7	Result Message (EML message 520).....	74
8.7.1	Message Schema Changes	75
8.7.2	Example XML	75
8.8	Cycle Times.....	76
9.	Frequently Asked Questions.....	77
9.1	Do all AEC messages have the same header?.....	77
9.2	How can I determine if the message was generated on Election Night?	79
9.3	How can I determine if any results have changed since the last feed?	81

9.4	How can I determine if there is an incorrect divisional Two Candidate Preferred selection on election night?	82
9.5	Why am I unable to see TCP results for a division(s)?.....	84
9.6	What are the main differences between the light and verbose messages?	85
9.6.1	Candidates elements	85
9.6.2	Vote elements.....	85
9.7	How can I determine if a Division has been declared?.....	86
9.7.1	Declared Contest Sample	86
9.7.2	Undeclared Contest	87
9.8	How can I determine the progress of the count?.....	88
9.9	How can I determine if the results are finalised?.....	90
9.10	When are Matched Historic votes available?	91
9.11	Are Polling Place Latitudes and Longitudes available?	91
9.11.1	Example with Latitude and Longitude available.....	91
9.11.2	Example with Latitude and Longitude unavailable.....	92
9.12	How can I determine the TCP matched historic for Polling Places that have returned First Preferences?	92
9.13	How can I determine a Candidate's position on the ballot paper?	94
9.14	Is there a message that contains the ballot paper definition?.....	95
9.15	What is the difference between Elected Historic and Incumbent?	95
10.	Frequently Asked Questions for Referendums	98
10.1	Are there sample feed messages available?.....	98
10.2	Have any changes been made to the Media Feed XML Schema for the Referendum?.....	98

1. Introduction

On election night the AEC delivers a live feed of election results for use by media organisations and interested third parties. The purpose of this publication is to provide information to users of the Media Feed System.

1.1 Audience

This document is intended for stakeholders interested in receiving a feed of election results from the AEC during Federal Elections. This document is suitable for use by the following staff working with the AEC, the media or other interested stakeholders:

- Business Users
- Election Analysts
- Business Analysts
- Software Developers
- Network Managers
- Network Engineers

1.2 Scope

This document provides information relating to the use of the Media Feed system. The document discusses:

1. Accessing the System
2. Feeds (Compressed Files)
3. XML Messages
4. Frequently Asked Questions

1.3 Related Documents

The full schema definition and associated documentation is available from the AEC at the following location: <https://www.aec.gov.au/media/mediafeed/index.htm>

2. System Overview

The objective of the AEC Media Feed system is to deliver uninterrupted, real-time election information and results to any media organisation or interested third party, anywhere in Australia or internationally, regardless of size or location.

To achieve this objective the AEC Media Feed system:

- Provides a feed of election results and information delivered to the media using the File Transfer Protocol (FTP) over the Internet
- Is implemented using a pull model and publishes the feed to an FTP site. Users of the system can then poll this location and download the feed as required
- Publishes the generated media feeds to the FTP site every 90 seconds on election night and every 15 minutes in the post-election period. Each media feed contains a complete set of election results
- Generates election results and information as a set of XML messages based on the Election Mark-up Language (EML) schema. EML is an international standard for the structured interchange of data among hardware, software and service providers engaged in providing election or voter services. The EML standard defines numerous message schemas that can be used during many different phases of the election process. Only a subset of these messages are relevant to the media feed system. Where applicable, the AEC will generate the following messages as part of the media feed:
 - EML Election Event Message (EML 110 message)
 - EML Candidate List Message (EML 230 message)
 - EML Referendum Options List Message (EML 630 message)
 - EML Count Message (EML 510 message)
 - EML Result Message (EML 520 message)
 - Polling Districts Message (Custom AEC message based on EML)
 - Senate Group Voting Tickets Message (Custom AEC message based on EML)
 - Ballot Paper Message (Custom AEC message based on EML)
 - Preload Results Message (Custom AEC message based on EML)
 - Verbose Results Message (Custom AEC message based on EML)
 - Lightweight Results Message (Custom AEC message based on EML)
 - Lightweight Results Message with polling place count progress (Custom AEC message based on EML)
- Compresses all XML messages into ZIP files called feeds, to optimise download times.

2.1 System Diagram

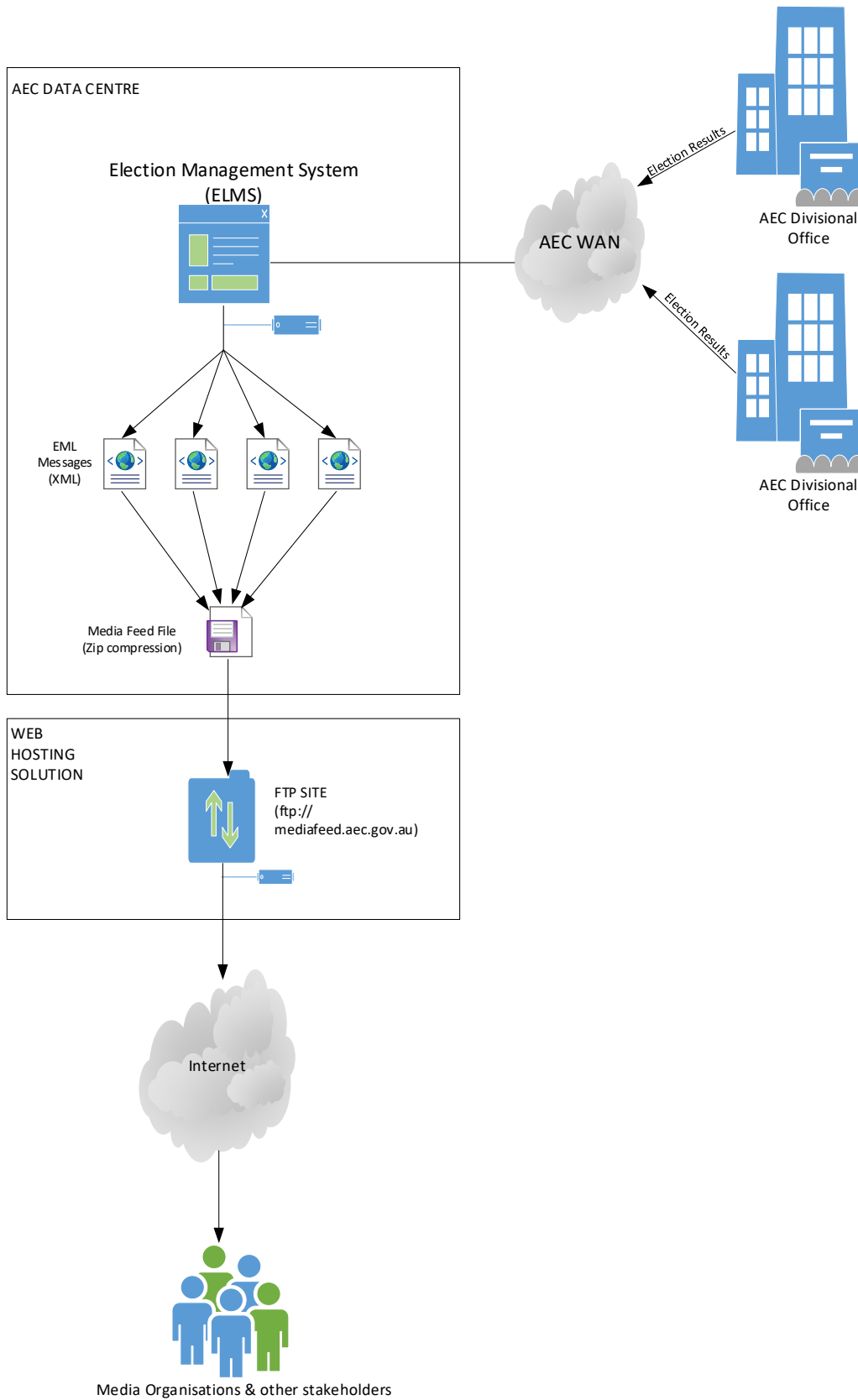

3. Accessing the Media Feed System

3.1 System Requirements

To use the Media Feed you will require the following:

- Internet Access
- Passive Mode File Transfer Protocol (FTP) Client Software
- Compression software that supports ZIP files
- XML Parser or Transformation Engine

3.1.1 Internet Access

To access the Media Feed you must have an Internet connection. If you have a firewall, ensure that it allows the FTP protocol and FTP Passive Mode. For best performance, a high-speed Internet connection is recommended.

3.1.2 FTP Client Software

FTP client software will allow you to connect to the Media Feed system and manage the process of downloading compressed feed files. The type of FTP client software you use will depend on your particular requirements. For example, if you are integrating the Media Feed system into your own real-time election results IT system, you may use a programmatic FTP component to automate the process of downloading feed files.

Please note: *Most modern Web Browsers no longer support the FTP protocol.*

The Media Feed FTP Site only supports Passive mode connections. If your systems do not already support Passive FTP mode, you must make the necessary changes to enable your systems to interface with the AEC's Media Feed site.

Recommendation

It is recommended to configure your FTP client to use the IP address provided by the server when establishing the passive mode connection, as the IP address returned by the server may be different to the IP address the connection was originally established on.

3.1.3 Authentication

The Media Feed is an anonymous FTP Site. If your FTP client prompts for a username, enter '*anonymous*' as the username. Any value is accepted for the password.

3.1.4 Compression software that supports the ZIP technology

A feed file consists of one or more XML messages containing the election results compressed using ZIP technology. To process a feed you must be able to extract the compressed XML messages from the feed file.

3.1.5 XML Parser or Transformation Engine

The election results provided by the Media Feed system are stored in XML files called messages. To process the election results stored in the messages you will need to parse or transform the file to provide the content in a format that supports your further processing.

3.2 Message Types

The Media Feed content is packaged in a number of different ways to satisfy the variety of users of the system. The message types are categorised by Granularity and Verbosity. These types are referred to throughout the document.

3.2.1 Granularity

Granularity defines the level to which the message provides details.

- Standard granularity provides results to the Polling District (Division) level for House of Representatives and Referendum and State level for Senate.
- Detailed granularity provides results to the Polling Place level for House of Representatives, Polling District (Division) level for Referendum and State level for Senate.

3.2.2 Verbosity

Verbosity defines the amount of information provided within a message.

- EML provides data in a number of EML messages. This exists to support users that have an existing EML-message based system.
- Light provides only dynamic data (vote counts etc.) and no static information (candidate names, party names, historic votes etc.).
- Light Progress is available for Detailed granularity and provides the same as a Light message with the inclusion of count progress at the polling place level.
- Preload provides all static information (candidate names, party names, historic votes etc.) and 'empty' dynamic information (vote counts etc.). It is designed to provide structural data for users to preload their election results system. It is identical in structure and level of content to the Verbose messages.
- Verbose provide all static and dynamic information.

3.3 Media Feed FTP Site

3.3.1 URL

To access the media feed system for a Federal Election, By-Election, or Referendum use the following URL: <ftp://mediafeed.aec.gov.au>

Please Note: This URL is available only during an election period from election night onwards.

3.3.2 Archive

Comprehensive files for several past elections are available at the media feed archive. To access the archive for the media feed system, use the following URL:

<ftp://mediafeedarchive.aec.gov.au>

Please Note: This URL is always available.

3.3.3 Folder Structure

The folder structure of the media feed FTP site is shown below:

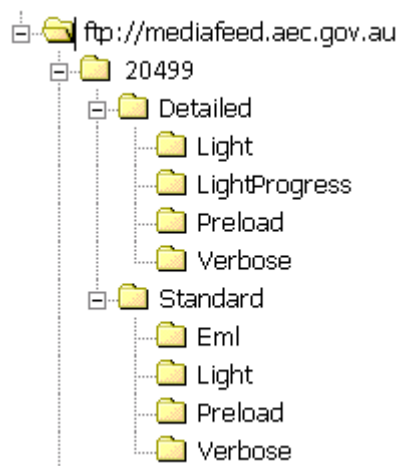

- All feeds for a particular electoral event will be placed in a single directory. The directory will be identified using the unique ID of the electoral event. For example, the directory name for the 2016 Federal Election is 20499.
- The FTP site may contain multiple directories to support concurrently running electoral events. For example, two by-elections running on the same weekend.
- The AEC publishes feeds with either standard or detailed granularity. Standard granularity files contain information and results to Federal Division level (where applicable). Detailed granularity files contain information to the polling place level (where applicable).

- All feeds generated with standard granularity are stored under the *Standard* directory.
- All feeds generated with detailed granularity are stored under the *Detailed* directory.
- Each verbosity of feed (light, light progress, verbose and preload) published by the AEC have an associated directory.
- All feed files generated during the election period for a particular type of feed are stored in the associated folder.
- Users of the FTP site can detect new feeds by listing all files in the associated directory and selecting the most recent file using either file attributes or the date/time encoded into the filename. Files listed alphabetically appear in ascending date order.
- Only those files for a particular granularity and verbosity combination appear in the associated directory.

3.4 Cycle Times

The preload feeds are published twice prior to the election. The first preload feed is available in the week after the close of nominations and updated in the week before the election. On election night the system publishes feeds every 90 seconds and once every 15 minutes in the post-election period.

Please Note: *Whilst confident of achieving these cycle times, the AEC makes no guarantees about the frequency of delivery.*

3.5 Recommended Feed Usage

Although the AEC is publishing numerous feeds with different granularity and verbosity generally you will only need to use one or two types of feeds. To determine the type of feed you require consider the following points.

3.5.1 Feed Granularity

Are you interested in election results at the polling place level for House of Representatives?

Yes	Use a detailed granularity feed
No	Use a standard granularity feed

Please Note: *If you are interested in results to the Division level but require the return status of individual polling places use the Detailed Light Progress feed.*

3.5.2 Feed Verbosity

How are you going to process the election results?	
I will parse the XML message, load my own database and use predictive techniques, calculations and aggregations other than those used by the AEC	Use a combination of a Preload and a Light feed for optimum parsing performance.
I will parse the XML message and load my own database however I want to use AEC calculations and aggregations.	Use a verbose feed that contain aggregations and calculations
I want to simply transform the XML message into another format for publishing	Use a verbose feed that contain aggregations and calculations

3.5.3 Examples

Below are examples of how different users may use the different types of feeds.

3.5.3.1 Television Network with full election coverage

Type	Television Network with full election coverage
Description	This type of user will televise the election in its entirety. The user will almost certainly have a sophisticated election IT system which may use predictive techniques and aggregations other than those used by the AEC. It is likely that this type of user will parse the data in the feed and load it into their custom application.

Requirements	Election results to polling place level Count progress to polling place level
Preload	<i>Detailed Preload</i>
Feed	<i>Detailed Light</i>

Requirements	Election results to division level Count progress to polling place level
Preload	<i>Standard Preload</i>
Feed	<i>Detailed Lightprogress</i>

Requirements	Election results to division level Count progress to division level
Preload	<i>Standard Preload</i>
Feed	<i>Standard Light</i>

3.5.3.2 Television Network with partial election coverage

Type	Television Network with partial election coverage
Description	This type of user may televise short focused election updates in between regular programming. The user may not have a dedicated election IT system. It is unlikely that this type of user will have a sophisticated system and will in general rely on AEC calculations and aggregations.

Requirements	Election results to division level Count progress to division level
Preload	N/A
Feed	<i>Standard Verbose</i>

3.5.3.3 Information Resellers

Type	Information Resellers
Description	This type of user will repackage the election results feed for use by other organisations. The user will almost certainly have an election results IT system. Their IT system may use predictive techniques other than those used by the AEC. It is likely that this type of user will parse the data in the feed and load it into their custom application.
Requirements	Election results to division level Count progress to division level
Preload	<i>Standard Preload</i>
Feed	<i>Standard Light</i>

3.5.3.4 Radio Broadcasters

Type	Radio Broadcasters
Description	This type of user may broadcast short focused election updates in between regular programming. It is unlikely that this type of user will have an election IT system and therefore will in general rely on AEC calculations and aggregations.
Requirements	Election results to division level Count progress to division level
Preload	N/A
Feed	<i>Standard Verbose</i>

3.5.3.5 Print and Online Media

Type	Print and Online Media
Description	This type of user may publish comprehensive election results and information in either newspapers, magazines or online. It is unlikely that this type of user will have an election IT system and will therefore rely on AEC calculations and aggregations. It is likely the user will simply take the feed and transform it into a format suitable for publishing.
Requirements	Election results to division level Count progress to division level
Preload	N/A
Feed	<i>Standard Verbose</i>

4. Feeds

All feeds are accessible from the media feed FTP site and are in ZIP format.

4.1 Compression

All XML messages in a feed are compressed using the ZIP technology before publishing. Where appropriate, a number of message files are compressed together into a single ZIP file.

4.2 Media feed file naming convention

The media feed file names are all structured as follows:

```
aec-mediafeed-<granularity>-<verbosity>-<transaction id>-<generation  
timestamp>.zip
```

where *<granularity>* is detailed or standard

<verbosity> is eml, light, lightprogress, preload or verbose

<transaction id> is a unique number identifying an election

<generation timestamp> is in the form YYYYMMDDHHMMSS

An example for the 2004 election might be:

```
aec-mediafeed-detailed-light-12246-20041012202444.zip
```

4.3 Feed Granularity

Following consultation, two distinct groups of users have emerged:

- Users that are interested in election results and/or count progress at a polling district (Division) level. This group, for performance reasons, does not wish for the inclusion of polling place count progress and/or results in the feed.
- Users who are interested in election results and/or count progress at the polling place level. This group has a requirement for the inclusion of polling place count progress and/or results in the feed to assist their analytical and predictive systems.

To service the needs of these two user groups the AEC publishes the media feed with two distinct levels of granularity, standard and detailed.

4.4 Standard Granularity Feeds

Because standard granularity feeds contain significantly less information they are much smaller in size than detailed granularity feeds.

The standard granularity feeds service the needs of most users.

4.4.1 Preload Feed

Users with their own election results IT system may use the Preload feed. The Preload feed will allow this type of user to pre-load static election information like candidates names before the election. Use of this feed facilitates the use of the Light feed during the election period.

4.4.1.1 Messages

The preload feed contains the following XML messages, where appropriate:

- Preload Results Message
- EML Election Event Message (EML 110 Message)
- EML Candidate List Message (EML 230 Message)
- Referendum Options List Message (EML 630 Message, only available for electoral events with a referendum or plebiscite)
- Polling Districts Message (Federal Divisions)
- Senate Group Voting Ticket Message
- AEC and EML XML Schema Files

4.4.1.2 Cycle

The preload feed is published twice prior to the election. The first preload feed will be available a week after the close of nominations and updated in the week before the election.

4.4.2 Verbose Feed

This feed contains up-to-date election results and information. The feed contains static data, such as candidate names, and dynamic data such as votes. The verbose feed also contains calculated results like swings and aggregated results to the state and national level. This feed is suitable for users who have their own IT system and who may or may not have pre-loaded data and is also suitable for those users who do not have an IT system and simply wish to transform the XML file into another format.

4.4.2.1 Messages

The verbose feed will contain the following messages:

- Verbose Results Message

4.4.2.2 Cycle

Every 90 seconds on election night and every 15 minutes in the post-election period.

4.4.3 Light Feed

This feed contains up-to-date election results and information. The feed contains only dynamic data like votes. The light feed does not contain calculated results like swings or aggregated results. This feed is only suitable for users who have their own IT system and have pre-loaded data using the Preload feed.

4.4.3.1 Messages

The light feed will contain the following messages:

- Light Results Message

4.4.3.2 Cycle

Every 90 seconds on election night and every 15 minutes in the post-election period.

4.4.4 Election Markup Language (EML) Feed

This feed contains up-to-date election results and information presented strictly using the EML international standard messages. The feed contains static data such as candidate names, and dynamic data such as votes. This feed is suitable for users who have their own IT system which is EML compliant and is also suitable for those users who do not have an IT system and simply wish to transform the XML file into another format.

4.4.4.1 Messages

The verbose feed contains the following messages:

- EML Count Message (EML 510)
- EML Results Message (EML 520)

4.4.4.2 Cycle

Every 90 seconds on election night and every 15 minutes in the post-election period.

4.5 Detailed Granularity Feeds

Users who are interested in election results and/or count progress at the polling place level use the detailed granularity feeds. Because detailed granularity feeds contain significantly more information, they are much larger in size than the standard granularity feeds.

The detailed granularity feeds will be only used by those organisations that have specialised requirements or complex predictive and analytical IT systems.

4.5.1 Preload Feed

Users that have their own election IT system may use the Preload feed. The preload feed will allow this type of user to pre-load static election information like candidates names before the election. Use of this feed will then facilitate the use of the Light or LightProgress feed during the election period.

4.5.1.1 Messages

The Preload feed will contain the following messages, where appropriate:

- Preload Results Message
- Election Event Message (EML 110)
- Candidate List Message (EML 230)
- Referendum Options List Message (EML 630, only available for electoral events with a referendum or plebiscite)
- Polling Districts Message
- Senate Group Voting Ticket Message
- AEC and EML XML Schema Files

4.5.1.2 Cycle

The preload feeds are published twice prior to the election. The first preload feed is available in the week after the close of nominations and updated in the week before the election.

4.5.2 Verbose Feed

This feed contains up-to-date election results and information. The feed contains static data such as candidate names and dynamic data such as votes. The verbose feed also contains calculated results such as swings and aggregated results to the state and national level. This feed is suitable for users who have their own IT system and who may or may not have pre-loaded data. It is also suitable for those users who do not have an IT system and simply wish to transform the XML file into another format.

4.5.2.1 Messages

The verbose feed contains the following message:

- Verbose Results Message

4.5.2.2 Cycle

Every 90 seconds on election night and every 15 minutes in the post-election period.

4.5.3 Light Feed

This feed contains up-to-date election results and information. The feed contains only dynamic data such as votes. The light feed does not contain calculated results such as

swings or aggregated results. This feed is only suitable for users who have their own IT system and have pre-loaded data using the Preload feed.

4.5.3.1 Messages

The light feed contains the following message:

- Light Results Message

4.5.3.2 Cycle

Every 90 seconds on election night and every 15 minutes in the post-election period.

4.5.4 Light Progress Feed

The feed has been developed for those users who are interested in election results at the polling district (Division) level, but require count progress at the polling place level.

This feed contains up-to-date election results and information. The feed contains only dynamic data for example the count progress of a polling place. The light feed does not contain calculated results such as swings or aggregated results. This feed is only suitable for users who have their own IT system and have pre-loaded data using the Preload feed.

4.5.4.1 Messages

The light feed contains the following message:

- Light Progress Results Message

4.5.4.2 Cycle

Every 90 seconds on election night and every 15 minutes in the post-election period.

5. Media Feed Messages

The AEC provides users with election results and information using a set of XML messages based on the Election Mark-up Language (EML). The EML standard defines numerous message schemas (file formats) that can be used during many different phases of the election process. Only a subset of these messages are relevant to the media feed system. Where applicable, the following EML based messages are generated as part of the media feed:

- Election Event Message (EML message 110)
- Candidate List Message (EML message 230)
- Referendum Options List Message (EML message 630)
- Count Message (EML message 510)
- Result Message (EML message 520)
- Polling Districts Message (Custom AEC message based on EML)
- Senate Group Voting Tickets Message (Custom AEC message based on EML)
- Ballot Paper Message (Custom AEC message based on EML)
- Preload Results Message (Custom AEC message based on EML)
- Verbose Results Message (Custom AEC message based on EML)
- Lightweight Results Message (Custom AEC message based on EML)
- Lightweight Results Message with polling place count progress (Custom AEC message based on EML)

Please Note: The purpose of this section is to provide a basic understanding of the messages involved in the AEC media feed system. However to completely understand the content of each message it is necessary to refer to the EML and AEC XML schema documentation provided as supporting files to this documentation.

5.1 Message file naming convention

5.1.1 EML Messages

The EML media feed message file names are all structured as follows:

```
eml-<message number>-<message name>-<transaction id>.xml
```

where *<message number>* is an identifying number of an EML message

<message name> is event, candidates, count or results

<transaction id> is a unique number identifying an election

An example for the 2004 election might be:

eml-230-candidates-12246.xml

5.1.2 AEC Messages

The AEC media feed message file names are all structured as follows:

aec-mediafeed-*<message type>*-*<granularity>*-*<verbosity>*-*<transaction id>*.xml

where *<message type>* is groupvotingtickets, pollingdistricts or results

<granularity> is detailed or standard (for message type results)

<verbosity> is light, lightprogress, preload or verbose (for message type results)

<transaction id> is a unique number identifying an election

An example for the 2004 election might be:

aec-mediafeed-results-detailed-light-12246.xml

5.2 White space and Formatting

All XML messages in all feed types are generated with white space and formatting. This ensures all messages are human readable.

5.3 Schema Documentation

5.3.1 Election Mark-up Language (EML)

Content in this section has been sourced from the following EML 5.0 documentation:

- EML v5.0 Process and Data Requirements.pdf
- EML v5.0 Schema Descriptions.pdf
- EML v5.0 Data Dictionary.xls

The full EML documentation can be found at the following website: OASIS Election and Voter Services Technical Committee, http://www.oasis-open.org/committees/tc_home.php?wg_abbrev=election

Please refer to these documents for more information on EML.

5.3.2 AEC Media Feed Message Schema

Full technical schema documentation for the AEC Media Feed messages can be downloaded from the AEC website at the following address:

<https://www.aec.gov.au/media/mediafeed/MediaFeedDocumentation.htm>

Please refer to these documents for more information on the AEC media feed schema.

Example message files can be accessed at: <ftp://mediafeedarchive.aec.gov.au/>

5.4 Understanding the XML schema

5.4.1 XML Software Engineering Tools

Because of its complex nature, the AEC recommends the use of an XML software engineering tool when investigating the XML schema. The Media Feed XML schema were designed and developed using XMLSpy (<http://www.altova.com>).

5.4.2 Reading schema diagrams in this document.

The schema diagrams in this document were created using XMLSpy. The following is a guide to their interpretation. The prefix "xs" denotes the XML schema namespace <http://www.w3.org/2001/XMLSchema>.

The diagram below represents a simple XML schema.

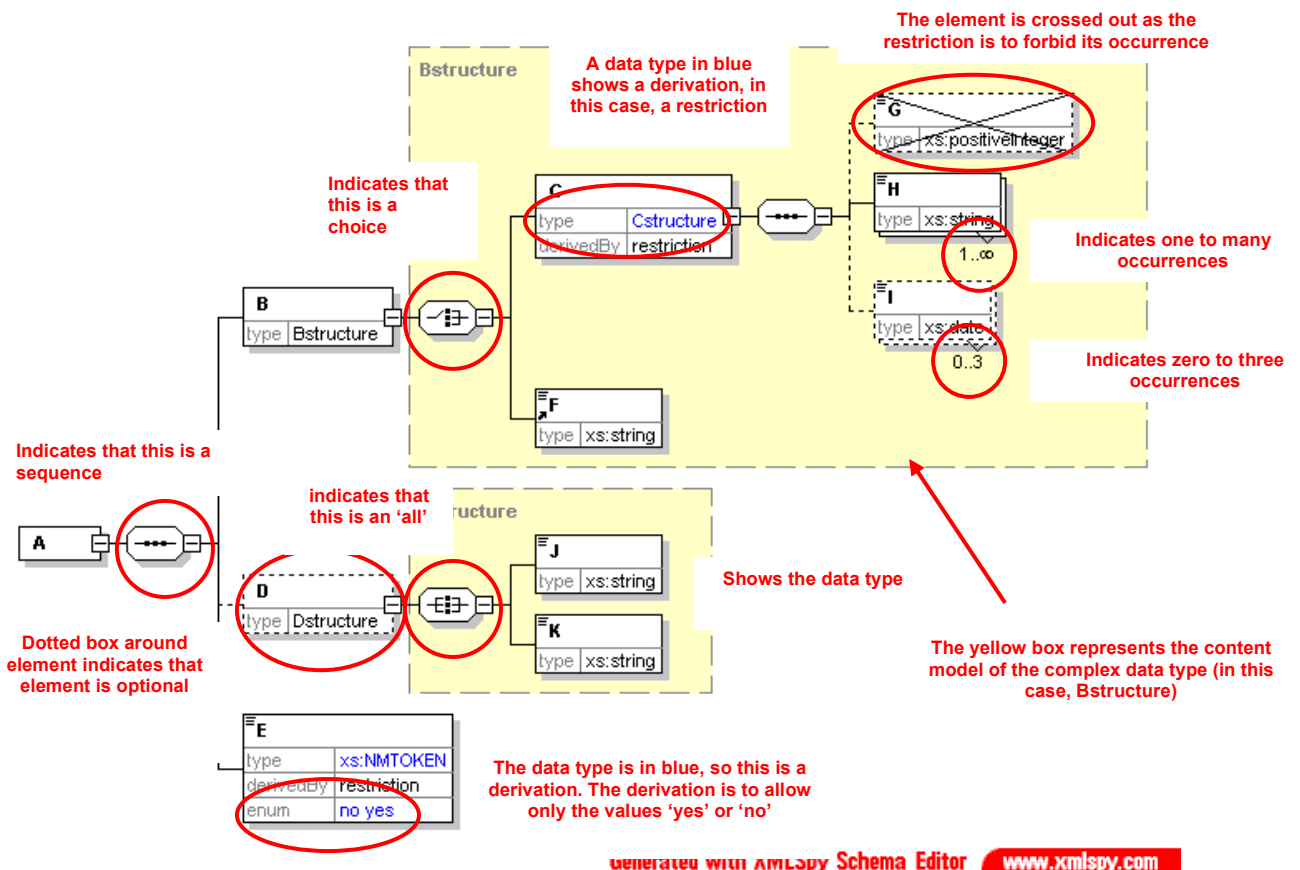

- The root element of an instance described by this schema is the element A.
- The content model of this element is a sequence of the elements B, D and E.

- The element B is of complex data type Bstructure. This contains a choice of either element C or element F.
- Element C is a restriction of another complex data type Cstructure. In this case, the restriction is to forbid the use of the element G (which is defined in Cstructure as optional). The other elements allowed are H, which can appear any number of times (but must appear at least once), and I, which can appear up to three times (or not at all).
- Element D is optional, and of data type Dstructure. This has a content model requiring all of elements J and K, which are both of type xs:string.
- Finally, element E is of simple data type Etype, which is restricted from the xs:NMTOKEN data type by only allowing the values 'yes' and 'no'.

6. Preload Messages

Users that have their own election IT systems may wish to pre-load static election information such as candidate names before the start of the election. Pre-loading information also facilitates the use of a lightweight feed during the election period.

The preload feed will contain the following messages, where appropriate:

- Preload Results Message
- Election Event Message (EML 110)
- Candidate List Message (EML 230)
- Referendum Options List Message (EML 630)
- Polling Districts Message
- Senate Group Voting Tickets Message
- Ballot Paper Message
- AEC and EML XML Schema Files

Most users will use only the Preload Results message to pre-load the key election information. Other messages provide supplementary information. For example, the Preload Results message contains the ID, name, ballot position and party for all candidates and the Candidate List message provide their telephone numbers and addresses.

6.1 Preload Results Message

6.1.1 Overview

This message is designed for users wishing to preload static election information such as candidate names, party names, historic votes and senate group structure prior to the election. This message is usually used in conjunction with light feeds, which are used during the election period.

6.1.2 Message Schema

The message is based on the XML schema in the file aec-mediafeed-results-v3-0.xsd.

6.1.3 Example XML

A portion of the Preload Results message for the 2004 Federal Election is shown below.

```
<?xml version="1.0" encoding="utf-8"?>
<MediaFeed Id="0f060b5f-e1c1-4e1f-9db3-af311c36be4b" Created="2006-12-20T17:05:48"
SchemaVersion="3" EmlVersion="5"xmlns="http://www.aec.gov.au/xml/schema/mediafeed"
xmlns:e1="urn:oasis:names:tc:evs:schema:e1"
xmlns:ds="http://www.w3.org/2000/09/xmldsig#"
xmlns:xal="urn:oasis:names:tc:ciq:xsdschema:xAL:2.0"
xmlns:xnl="urn:oasis:names:tc:ciq:xsdschema:xNL:2.0"
xmlns:ts="urn:oasis:names:tc:evs:schema:e1:ts"
xmlns:xs="http://www.w3.org/2001/XMLSchema-instance"
```

```

xs:schemaLocation="http://www.aec.gov.au/xml/schema/mediafeed ../Schema/AEC/aec-
mediafeed-results-v3-0.xsd">
  <ManagingAuthority>
    <eml:AuthorityIdentifier Id="AEC">Australian Electoral
Commission</eml:AuthorityIdentifier>
  </ManagingAuthority>
  <MessageLanguage>en</MessageLanguage>
  <MessageGenerator>
    <Name>Virtual Tally Room</Name>
    <Environment>DEV</Environment>
    <Site>Primary</Site>
    <Server>DEV01</Server>
    <Platform>x64</Platform>
    <Version>6.0.6.5754</Version>
  </MessageGenerator>
  <Cycle Created="2006-11-20T10:50:42">e28bc89e-180d-4520-9fcb-8c728d3d0864</Cycle>
  <Results Updated="2004-12-10T15:35:46" Phase="Preload" Verbosity="Preload"
Granularity="Standard">
    <eml:EventIdentifier Id="12246">
      <eml:EventName>2004 Federal Election</eml:EventName>
    </eml:EventIdentifier>
    <Election Updated="2004-11-26T14:36:56">
      <eml:ElectionIdentifier Id="H">
        <eml:ElectionName>House of Representatives Election</eml:ElectionName>
        <eml:ElectionCategory>House</eml:ElectionCategory>
      </eml:ElectionIdentifier>
      <House>
        <Contests>
          <Contest>
            <eml:ContestIdentifier Id="101">
              <eml:ContestName>Canberra</eml:ContestName>
            </eml:ContestIdentifier>
            <PollingDistrictIdentifier Id="101" ShortCode="CANB">
              <Name>Canberra</Name>
              <StateIdentifier Id="ACT" />
            </PollingDistrictIdentifier>
            <Enrolment CloseOfRolls="108369" Historic="108959">109476</Enrolment>
            <FirstPreferences PollingPlacesReturned="0" PollingPlacesExpected="39">
              <Candidate>
                <eml:CandidateIdentifier Id="15421">
                  <eml:CandidateName>ELLERMAN, Sue</eml:CandidateName>
                </eml:CandidateIdentifier>
                <eml:AffiliationIdentifier Id="37" ShortCode="GRN">
                  <eml:RegisteredName>The Greens</eml:RegisteredName>
                </eml:AffiliationIdentifier>
                <BallotPosition>1</BallotPosition>
                <Elected Historic="false">>false</Elected>
                <Incumbent Notional="false">>false</Incumbent>
                <Votes Historic="62680" Percentage="0" Swing="0"
MatchedHistoric="0">0</Votes>
                <VotesByType>
                  <Votes Type="Ordinary" Historic="7687" Percentage="0"
Swing="0">0</Votes>
                  <Votes Type="Absent" Historic="366" Percentage="0"
Swing="0">0</Votes>
                  <Votes Type="Provisional" Historic="141" Percentage="0"
Swing="0">0</Votes>
                  <Votes Type="PrePoll" Historic="1713" Percentage="0"
Swing="0">0</Votes>
                  <Votes Type="Postal" Historic="366" Percentage="0"
Swing="0">0</Votes>
                </VotesByType>
              </Candidate>

```

6.1.4 Estimated Message Size

Electoral Event	Size (Standard)	Size (Detailed)
General Election	2.5 MB	17MB
General Election including Referendum	2.7 MB	17.2 MB
House of Representatives By-election	50 KB	75 KB
Referendum	200 KB	200 KB

6.2 Election Event Message (EML 110)

6.2.1 Overview

This message is used for providing information about an election or set of elections. The message contains information about the electoral event (in this case a Federal Election), the elections to be held during the event (House of Representatives, Senate and maybe a Referendum). The message also details the different contests within an election. For example, a contest could be considered as 5 candidates running for the seat of Fraser in the House of Representative. In the AEC Media Feed system this message schema will be used to package the follow information:

- Name of the electoral event
- Event and Election related dates
- The list of elections and contests in the electoral event, for example House of Representatives, Senate and a Referendum

The media feed system generates a single election event message for every Federal electoral event. For example, if there are two concurrent by-elections being held on the same weekend, the media feed system creates an event message for each of the by-elections.

6.2.2 Message Schema

The message is based on the XML schema in the file 110-electionevent-v5-0.xsd

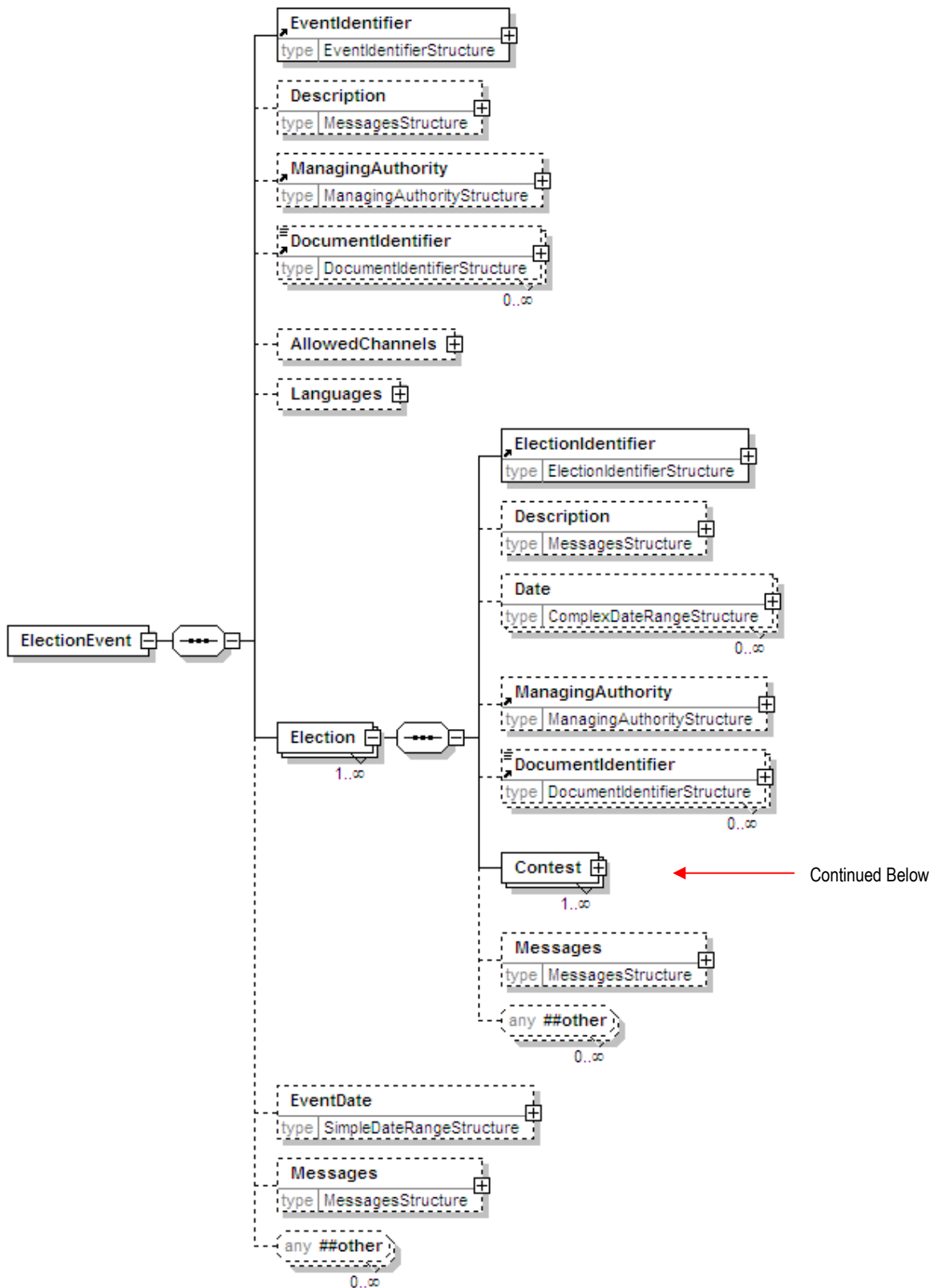

Continued Below

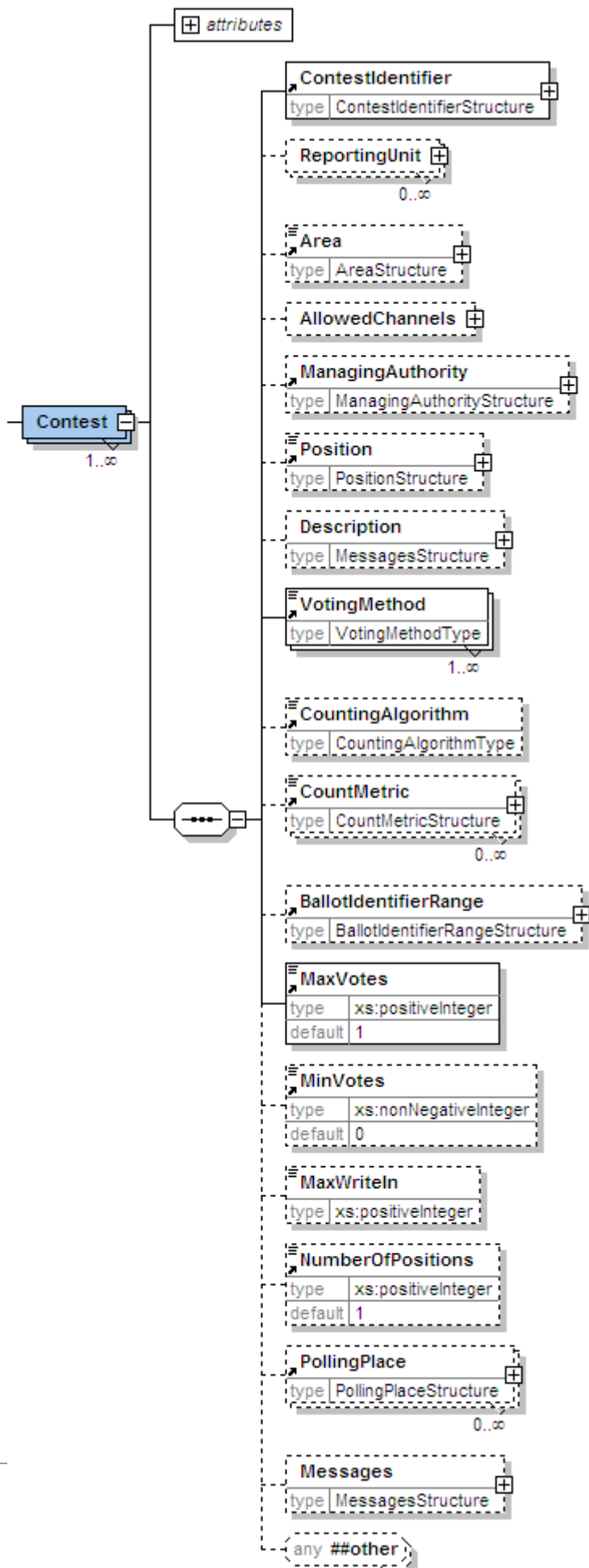

6.2.3 Example XML

A portion of the Election Event Message for the 2007 Federal Election is shown below.

```
<?xml version="1.0" encoding="utf-8"?>
<EML xmlns="urn:oasis:names:tc:evs:schema:eml"
xmlns:ds="http://www.w3.org/2000/09/xmldsig#
xmlns:xal="urn:oasis:names:tc:ciq:xsd:schema:xAL:2.0"
xmlns:xnl="urn:oasis:names:tc:ciq:xsd:schema:xNL:2.0"
xmlns:ts="urn:oasis:names:tc:evs:schema:eml:ts"
xmlns:xs="http://www.w3.org/2001/XMLSchema-instance"
xs:schemaLocation="urn:oasis:names:tc:evs:schema:eml ../Schema/EML/110-electionevent-
v5-0.xsd" SchemaVersion="5"
Id="ec65949f-67ae-48e6-a404-206f3b7f12ae">
  <TransactionId>ac3e41d8-5b5f-4801-ade7-1bb332090f09</TransactionId>
  <ElectionEvent>
    <EventIdentifier Id="13745">
      <EventName>2007 Federal Election</EventName>
    </EventIdentifier>
    <ManagingAuthority>
      <AuthorityIdentifier Id="AEC">Australian Electoral
Commission</AuthorityIdentifier>
      <AuthorityAddress AddressType="Office">
        <xal:AddressLines>
          <xal:AddressLine Type="AddressLine1">West Block Offices</xal:AddressLine>
          <xal:AddressLine Type="AddressLine2">Queen Victoria
Terrace</xal:AddressLine>
          <xal:AddressLine Type="Suburb">Parkes</xal:AddressLine>
          <xal:AddressLine Type="State">ACT</xal:AddressLine>
          <xal:AddressLine Type="Postcode">2600</xal:AddressLine>
        </xal:AddressLines>
      </AuthorityAddress>
    </ManagingAuthority>
    <Election>
      <ElectionIdentifier Id="H">
        <ElectionName>House of Representatives Election</ElectionName>
        <ElectionCategory>House</ElectionCategory>
      </ElectionIdentifier>
      <Date Type="PollingDay">
        <SingleDate>2007-11-24T00:00:00</SingleDate>
      </Date>
      <Contest>
        <ContestIdentifier Id="179" ShortCode="ADEL">
          <ContestName>Adelaide</ContestName>
        </ContestIdentifier>
        <Area Id="179" Type="division">Adelaide</Area>
        <Position>Member of the House of Representatives for the Federal Division of
Adelaide</Position>
        <VotingMethod>other</VotingMethod>
        <MaxVotes>1</MaxVotes>
        <NumberOfPositions>1</NumberOfPositions>
      </Contest>
      <Contest>
        <ContestIdentifier Id="197" ShortCode="ASTO">
          <ContestName>Aston</ContestName>
        </ContestIdentifier>
        <Area Id="197" Type="division">Aston</Area>
        <Position>Member of the House of Representatives for the Federal Division of
Aston</Position>
        <VotingMethod>other</VotingMethod>
        <MaxVotes>1</MaxVotes>
        <NumberOfPositions>1</NumberOfPositions>
      </Contest>
    </Election>
  </ElectionEvent>
</EML>
```

6.2.4 Estimated Message Size

Electoral Event	File Size
General Election	55 K
General Election including Referendum	57 KB
House of Representatives By-election	2 KB
Referendum	2 KB

6.3 Candidate List Message (EML 230)

6.3.1 Overview

This message is used for providing the list of candidates for the contests within an electoral event. The list contains each candidate's name, address, optional affiliation (party) and other information. In the AEC media feed system this message schema will be used to package the following information.

- List of Candidates for the House of Representatives
- List of Candidates for the Senate

The AEC media feed system generates a single candidate list message that will contain the list of candidates for all elections (House of Representatives and Senate, or just House of Representatives for a by-election).

6.3.2 Message Schema

The message is based on the XML schema in the file 230-candidatelist-v5-0.xsd

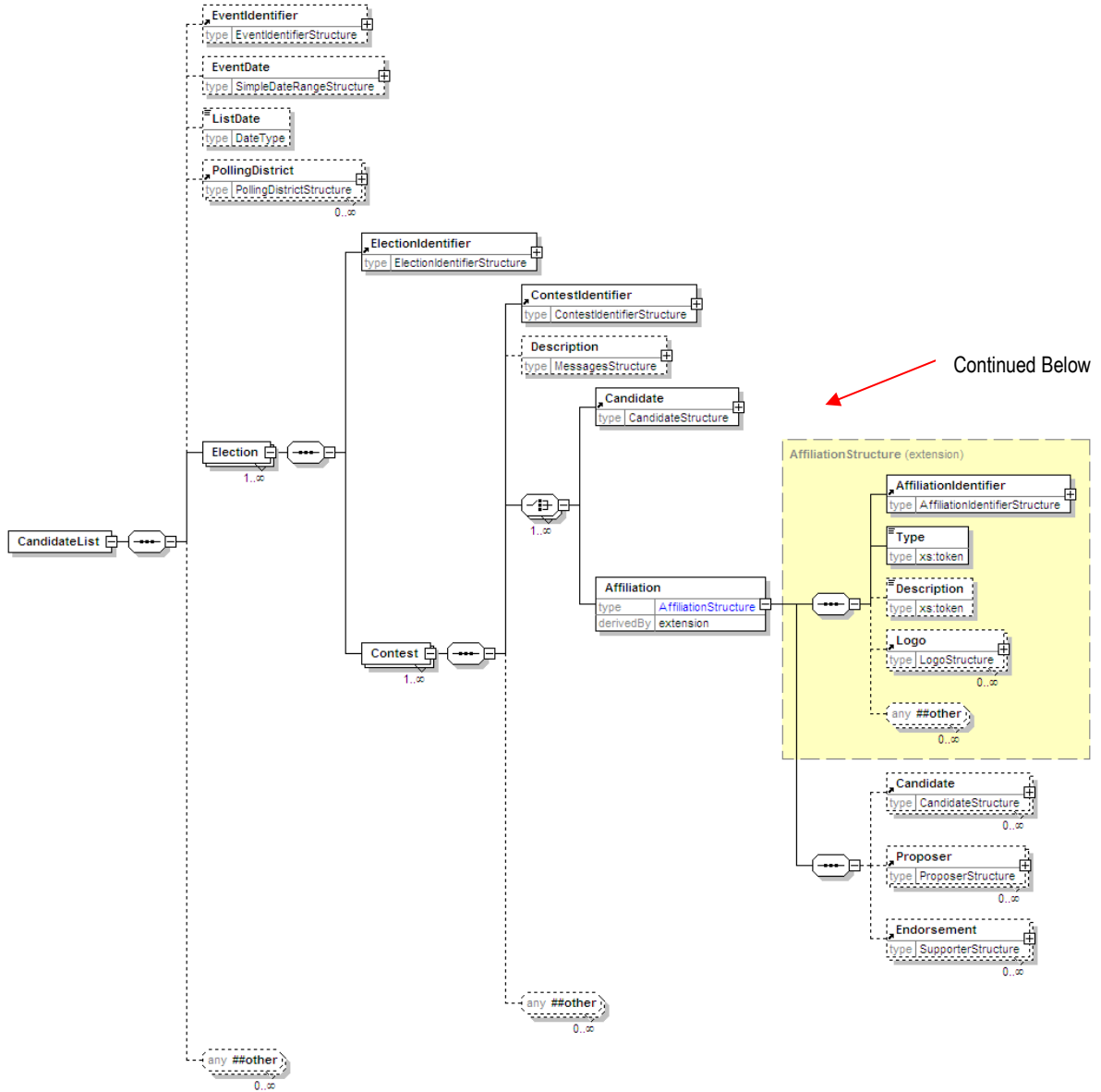

Generated by XmlSpy

www.altova.com

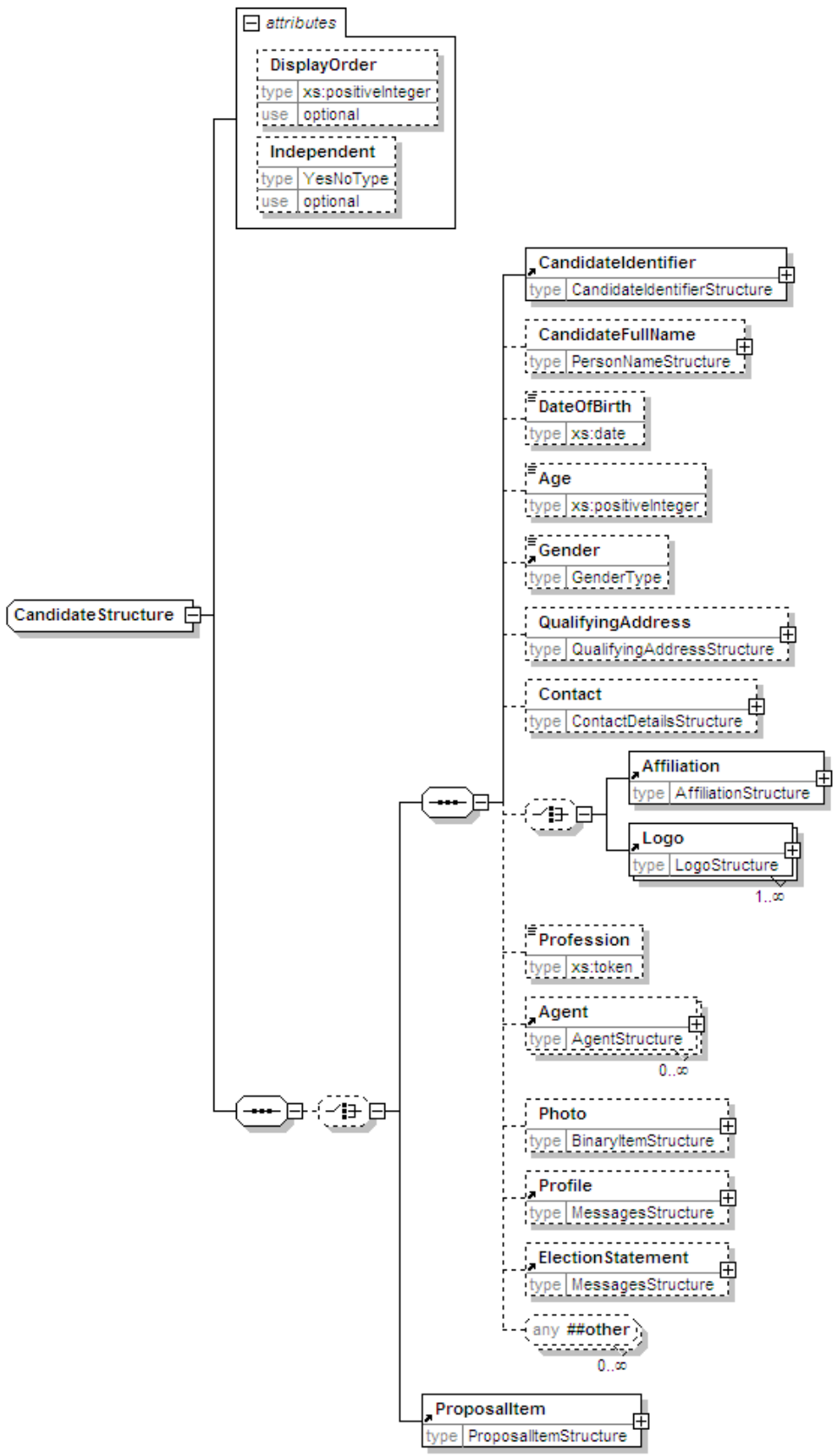

Generated by XmlSpy

www.altova.com

6.3.3 Example XML

A portion of the Candidate List Message for the 2007 Federal Election is shown below.

```
<?xml version="1.0" encoding="utf-8"?>
<EML xmlns="urn:oasis:names:tc:evs:schema:eml"
xmlns:ds="http://www.w3.org/2000/09/xmldsig#"
xmlns:xal="urn:oasis:names:tc:ciq:xsdschema:xAL:2.0"
xmlns:xnl="urn:oasis:names:tc:ciq:xsdschema:xNL:2.0"
xmlns:ts="urn:oasis:names:tc:evs:schema:eml:ts"
xmlns:xs="http://www.w3.org/2001/XMLSchema-instance"
xs:schemaLocation="urn:oasis:names:tc:evs:schema:eml ../Schema/EML/230-candidatelist-
v5-0.xsd" SchemaVersion="5" Id="38f3bc47-c36e-4b87-b417-01a088019181">
  <TransactionId>ac3e41d8-5b5f-4801-ade7-1bb332090f09</TransactionId>
  <CandidateList>
    <EventIdentifier Id="13745">
      <EventName>2007 Federal Election</EventName>
    </EventIdentifier>
    <Election>
      <ElectionIdentifier Id="H">
        <ElectionName>House of Representatives Election</ElectionName>
        <ElectionCategory>House</ElectionCategory>
      </ElectionIdentifier>
      <Contest>
        <ContestIdentifier Id="179" ShortCode="ADEL">
          <ContestName>Adelaide</ContestName>
        </ContestIdentifier>
        <Candidate Independent="no">
          <CandidateIdentifier Id="17610">
            <CandidateName>SLAPE, Dennis</CandidateName>
          </CandidateIdentifier>
          <CandidateFullName>
            <xnl:PersonName>
              <xnl:FirstName>Dennis Stanley John</xnl:FirstName>
              <xnl:FirstName Type="BallotPaper">Dennis</xnl:FirstName>
              <xnl:LastName>SLAPE</xnl:LastName>
            </xnl:PersonName>
          </CandidateFullName>
          <Gender>male</Gender>
          <QualifyingAddress AddressType="Residential">
            <xal:AddressLines>
              <xal:AddressLine Type="AddressLine1">5 Monmouth Rd</xal:AddressLine>
              <xal:AddressLine Type="Suburb">WESTBOURNE PARK</xal:AddressLine>
              <xal:AddressLine Type="State">SA</xal:AddressLine>
              <xal:AddressLine Type="Postcode">5041</xal:AddressLine>
            </xal:AddressLines>
          </QualifyingAddress>
          <Contact>
            <MailingAddress AddressType="Postal">
              <xal:AddressLines>
                <xal:AddressLine Type="AddressLine1">5 Monmouth Rd</xal:AddressLine>
                <xal:AddressLine Type="Suburb">WESTBOURNE PARK</xal:AddressLine>
                <xal:AddressLine Type="State">SA</xal:AddressLine>
                <xal:AddressLine Type="Postcode">5041</xal:AddressLine>
              </xal:AddressLines>
            </MailingAddress>
            <Email>sa@familyfirst.org.au</Email>
            <Telephone>
              <Number>04 0579 5682</Number>
            </Telephone>
            <Telephone>
              <Number>04 0579 5682</Number>
            </Telephone>
            <Telephone Mobile="yes">
              <Number>0405 795 682</Number>
            </Telephone>
          </Contact>
          <Affiliation>
            <AffiliationIdentifier Id="1129" ShortCode="FFP">
              <RegisteredName>Family First Party</RegisteredName>
            </AffiliationIdentifier>
          </Affiliation>
        </Contest>
      </Election>
    </CandidateList>
  </EML>
```

```

        <Type>Party</Type>
    </Affiliation>
    <Profession>Manager</Profession>
</Candidate>
    
```

6.3.4 Estimated Message Size

Electoral Event	File Size
General Election	1.8 MB
General Election including Referendum	1.8 MB
House of Representatives By-election	40 KB
Referendum	N/A

6.4 Referendum Options List Message (EML 630)

6.4.1 Overview

This message defines the lists of proposals (questions) for a referendum. Each proposal in a referendum counts as an election, so each election identified will hold a single proposal. In the AEC media feed system this message packages the list of questions for a referendum. This message is generated if there is a referendum election listed in the Election Event message (110).

6.4.2 Message Schema

The message is based on the XML schema in the file 630-optionslist-v5-0.xsd

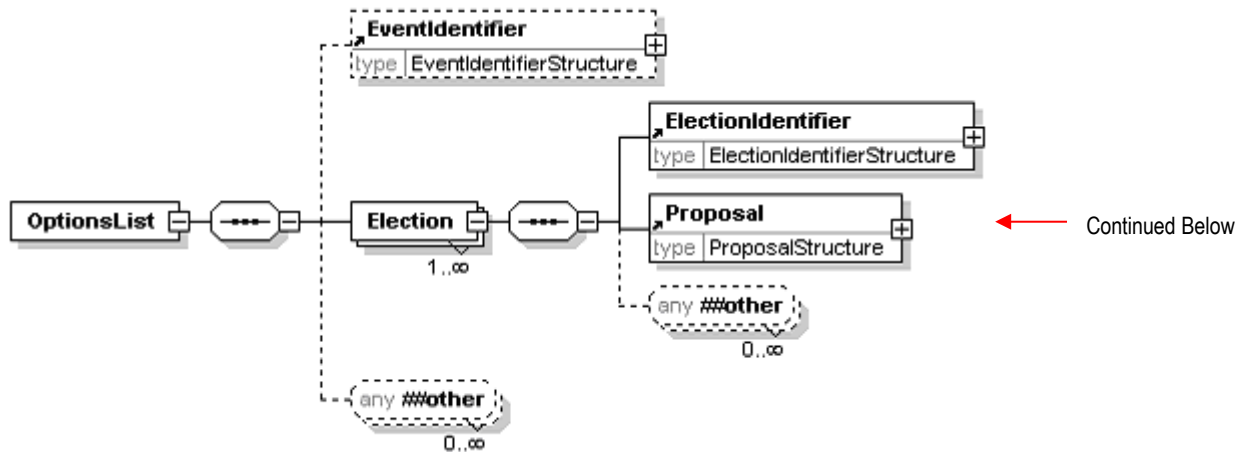

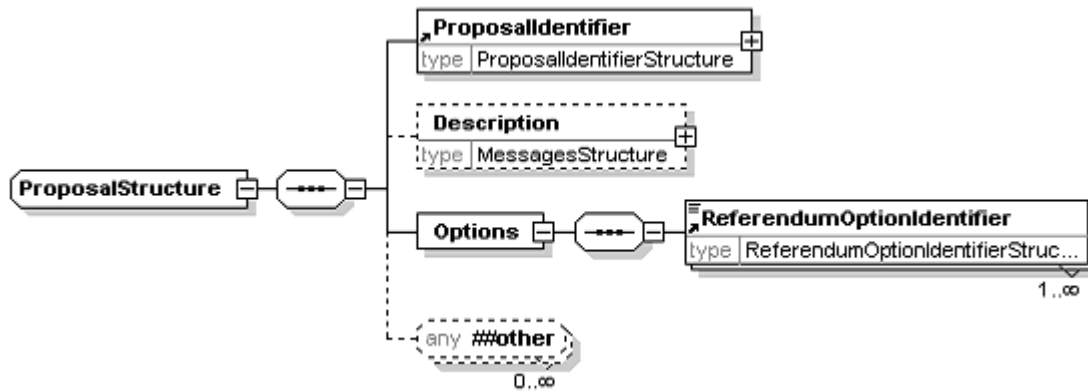

6.4.3 Example XML

An example of the Referendum Options List message for the 1999 Federal Referendum is shown below.

```

<?xml version="1.0" encoding="UTF-8"?>
<EML xmlns="urn:oasis:names:tc:evs:schema:eml"
xmlns:ds="http://www.w3.org/2000/09/xmldsig#"
xmlns:xal="urn:oasis:names:tc:ciq:xsd:schema:xAL:2.0"
xmlns:xnl="urn:oasis:names:tc:ciq:xsd:schema:xNL:2.0"
xmlns:ts="urn:oasis:names:tc:evs:schema:eml:ts"
xmlns:xs="http://www.w3.org/2001/XMLSchema-instance"
xs:schemaLocation="urn:oasis:names:tc:evs:schema:eml ../Schema/EML/630-optionlist-v5-
0.xsd" SchemaVersion="5" Id="69368cb9-d33a-47a0-8e56-5caf74286b6d">
  <TransactionId>e28bc89e-180d-4520-9fcb-8c728d3d0864</TransactionId>
  <OptionsList>
    <EventIdentifier Id="9399">
      <EventName>1999 Referendum</EventName>
    </EventIdentifier>
    <Election>
      <ElectionIdentifier Id="Q1">
        <ElectionName>The Republic</ElectionName>
        <ElectionCategory>Referendum</ElectionCategory>
      </ElectionIdentifier>
      <Proposal>
        <ProposalIdentifier Id="1">
          <ProposalName>The Republic</ProposalName>
        </ProposalIdentifier>
        <Description>
          <Message Lang="EN">To alter the Constitution to establish the Commonwealth
of Australia as a republic with the Queen and Governor-General being replaced by a
President appointed by a two-thirds majority of the Members of the Commonwealth
Parliament.</Message>
        </Description>
        <Options>
          <ReferendumOptionIdentifier Id="Y">Yes</ReferendumOptionIdentifier>
          <ReferendumOptionIdentifier Id="N">No</ReferendumOptionIdentifier>
        </Options>
      </Proposal>
    </Election>
    <Election>
      <ElectionIdentifier Id="Q2">
        <ElectionName>The Preamble</ElectionName>
        <ElectionCategory>Referendum</ElectionCategory>
      </ElectionIdentifier>
      <Proposal>
        <ProposalIdentifier Id="2">
          <ProposalName>The Preamble</ProposalName>
        </ProposalIdentifier>
        <Description>
          <Message Lang="EN">To alter the Constitution to insert a preamble.</Message>
        </Description>
      </Proposal>
    </Election>
  </OptionsList>
</EML>
    
```

```

    <Options>
      <ReferendumOptionIdentifier Id="Y">Yes</ReferendumOptionIdentifier>
      <ReferendumOptionIdentifier Id="N">No</ReferendumOptionIdentifier>
    </Options>
  </Proposal>
</Election>
</OptionsList>
</EML>

```

6.4.4 Message Size

Electoral Event	File Size
General Election	N/A
General Election including Referendum (2 Questions)	3 KB
House of Representatives By-election	N/A
Referendum (2 Questions)	3 KB

6.5 Polling Districts Message

This message defines the list of polling districts (Divisions) and their associated polling places for the electoral event. Please note this message is used to convey Polling Place structural information instead of the EML 110 Election Event message.

6.5.1 Message Schema

The message is based on the XML schema in the file aec-mediafeed-pollingdistricts-v3-0.xsd

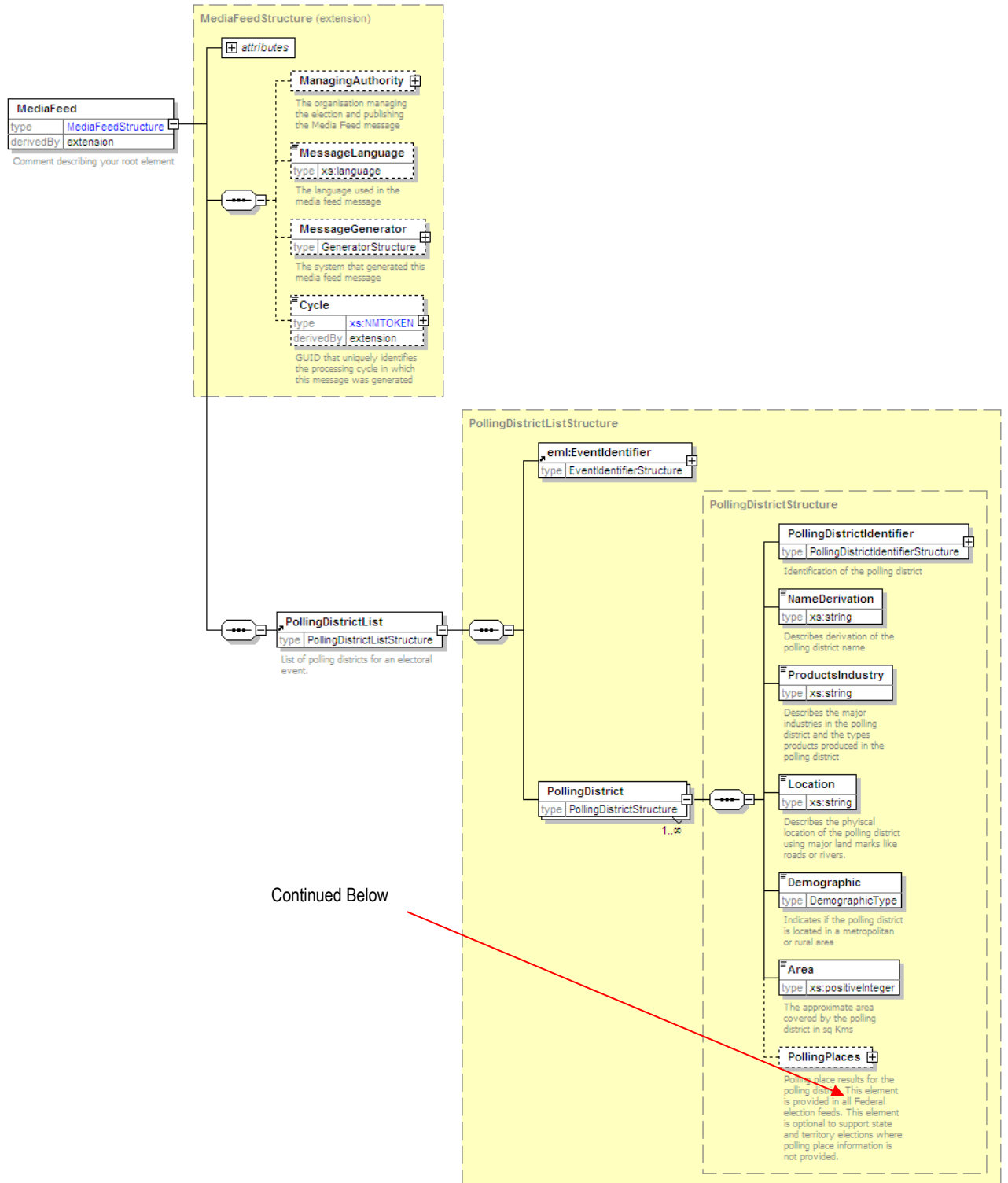

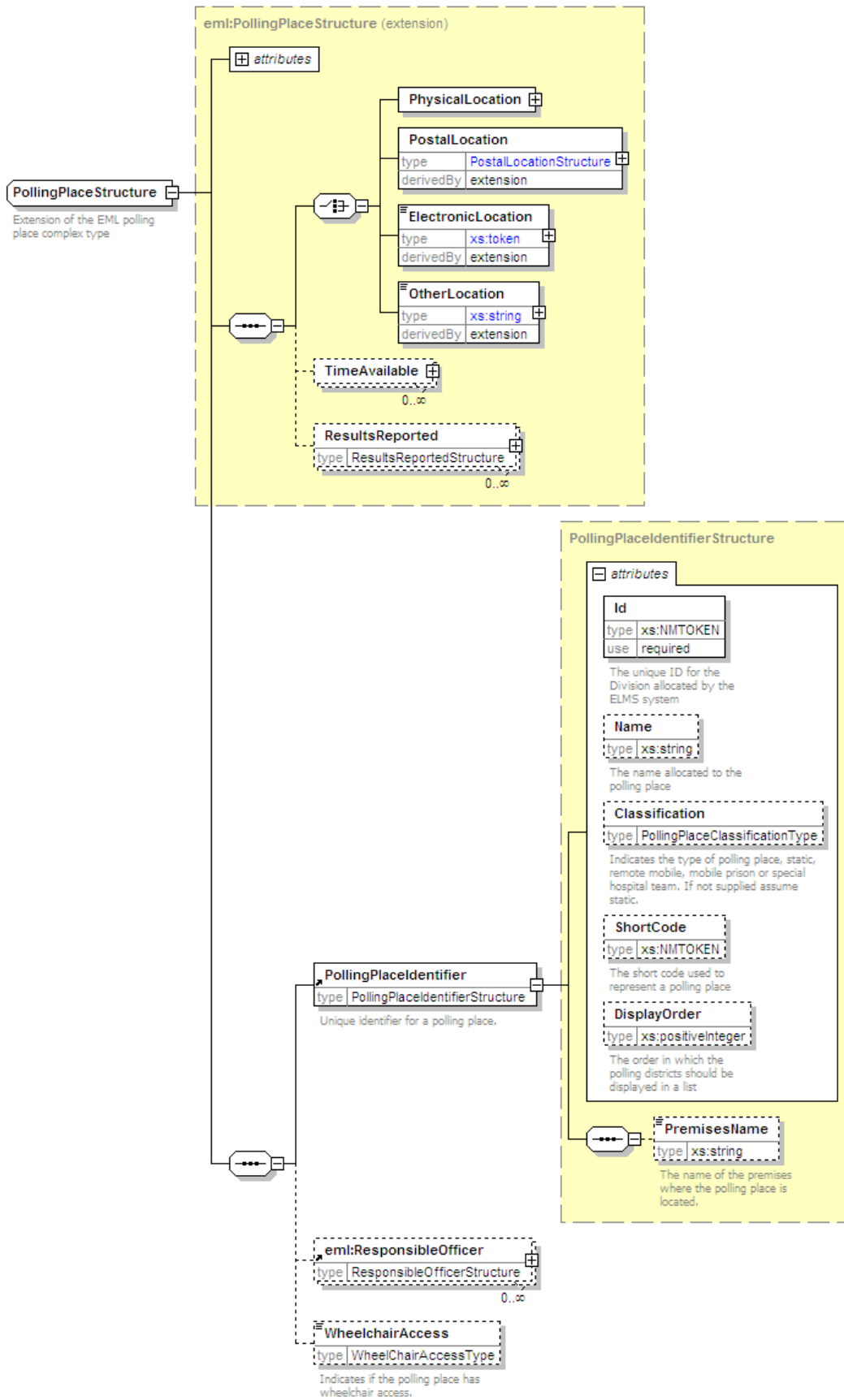

6.5.2 Example XML

An example of a partial Polling Districts message for the 2004 Federal Election is shown below.

```
<?xml version="1.0" encoding="utf-8"?>
<MediaFeed Id="5a9181c9-119d-4bbb-aa36-22a8648dcd51" Created="2010-05-30T14:36:50"
SchemaVersion="3" EmlVersion="5" xmlns="http://www.aec.gov.au/xml/schema/mediafeed"
xmlns:eml="urn:oasis:names:tc:evs:schema:eml"
xmlns:ds="http://www.w3.org/2000/09/xmldsig#"
xmlns:xal="urn:oasis:names:tc:ciq:xdschema:xAL:2.0"
xmlns:xnl="urn:oasis:names:tc:ciq:xdschema:xNL:2.0"
xmlns:ts="urn:oasis:names:tc:evs:schema:eml:ts"
xmlns:xs="http://www.w3.org/2001/XMLSchema-instance"
xs:schemaLocation="http://www.aec.gov.au/xml/schema/mediafeed ../Schema/AEC/aec-
mediafeed-pollingdistricts-v3-0.xsd">
  <ManagingAuthority>
    <eml:AuthorityIdentifier Id="AEC">Australian Electoral
Commission</eml:AuthorityIdentifier>
  </ManagingAuthority>
  <MessageLanguage>en</MessageLanguage>
  <MessageGenerator>
    <Name>Virtual Tally Room</Name>
    <Environment>DEV</Environment>
    <Site>PARKES</Site>
    <Server>DEV01</Server>
    <Platform>x64</Platform>
    <Version>6.0.6.5754</Version>
  </MessageGenerator>
  <Cycle Created="2007-11-24T20:00:24">ac3e41d8-5b5f-4801-ade7-1bb332090f09</Cycle>
  <PollingDistrictList>
    <eml:EventIdentifier Id="13745">
      <eml:EventName>2007 Federal Election</eml:EventName>
    </eml:EventIdentifier>
    <PollingDistrict>
      <PollingDistrictIdentifier Id="179" ShortCode="ADEL">
        <Name>Adelaide</Name>
        <StateIdentifier Id="SA" />
      </PollingDistrictIdentifier>
      <NameDerivation>Named after the city of Adelaide which in turn was named after
Queen Adelaide, wife of William IV.</NameDerivation>
      <ProductsIndustry>Markets, newspapers, military barracks, universities,
brewery, Coca-Cola bottlers, rail/bus terminals and Adelaide central business
district.</ProductsIndustry>
      <Location>The division of Adelaide covers an area of approximately 75 sq km
from Grand Junction Road in the north to Cross Road in the south. Suburbs include
Ashford, Clarence Park, Enfield, Goodwood, Kent Town, Keswick, Kilburn, Maylands,
North Adelaide, Northgate, Norwood, Parkside, Prospect, Rose Park, St Peters, Toorak
Gardens, Unley, Walkerville and the City of Adelaide.</Location>
      <Demographic>InnerMetropolitan</Demographic>
      <Area>75</Area>
      <PollingPlaces>
        <PollingPlace Channel="polling">
          <eml:PhysicalLocation Id="6648">
            <eml:Address AddressDetailsKey="Adelaide (Adelaide)">
              <xal:PostalServiceElements Type="GDA94">
                <xal:AddressLatitude>-34.921200</xal:AddressLatitude>
                <xal:AddressLongitude>138.599700</xal:AddressLongitude>
              </xal:PostalServiceElements>
              <xal:AddressLines>
                <xal:AddressLine Type="Premises">Origin Energy
House</xal:AddressLine>
                <xal:AddressLine Type="AddressLine1">Ground Floor</xal:AddressLine>
                <xal:AddressLine Type="AddressLine2">1 King William
St</xal:AddressLine>
                <xal:AddressLine Type="Suburb">ADELAIDE</xal:AddressLine>
                <xal:AddressLine Type="State">SA</xal:AddressLine>
                <xal:AddressLine Type="Postcode">5000</xal:AddressLine>
              </xal:AddressLines>
            </eml:Address>
          </eml:PhysicalLocation>
        </PollingPlace>
      </PollingPlaces>
    </PollingDistrict>
  </PollingDistrictList>

```

```

</eml:PhysicalLocation>
<PollingPlaceIdentifier Id="6648" Name="Adelaide (Adelaide)" />
<WheelchairAccess>Full</WheelchairAccess>
</PollingPlace>
    
```

6.5.3 Estimated Message Size

Electoral Event	XML File Size
General Election	5 MB
General Election including Referendum	5 MB
House of Representatives By-election	20 KB
Referendum	5 MB

6.6 Senate Group Voting Tickets Message

This message contains the list of Senate Groups and the Group Voting Ticket(s) for each Senate Group.

6.6.1 Message Schema

The message is based on the XML schema aec-mediafeed-groupvotingtickets-v3-0.xsd

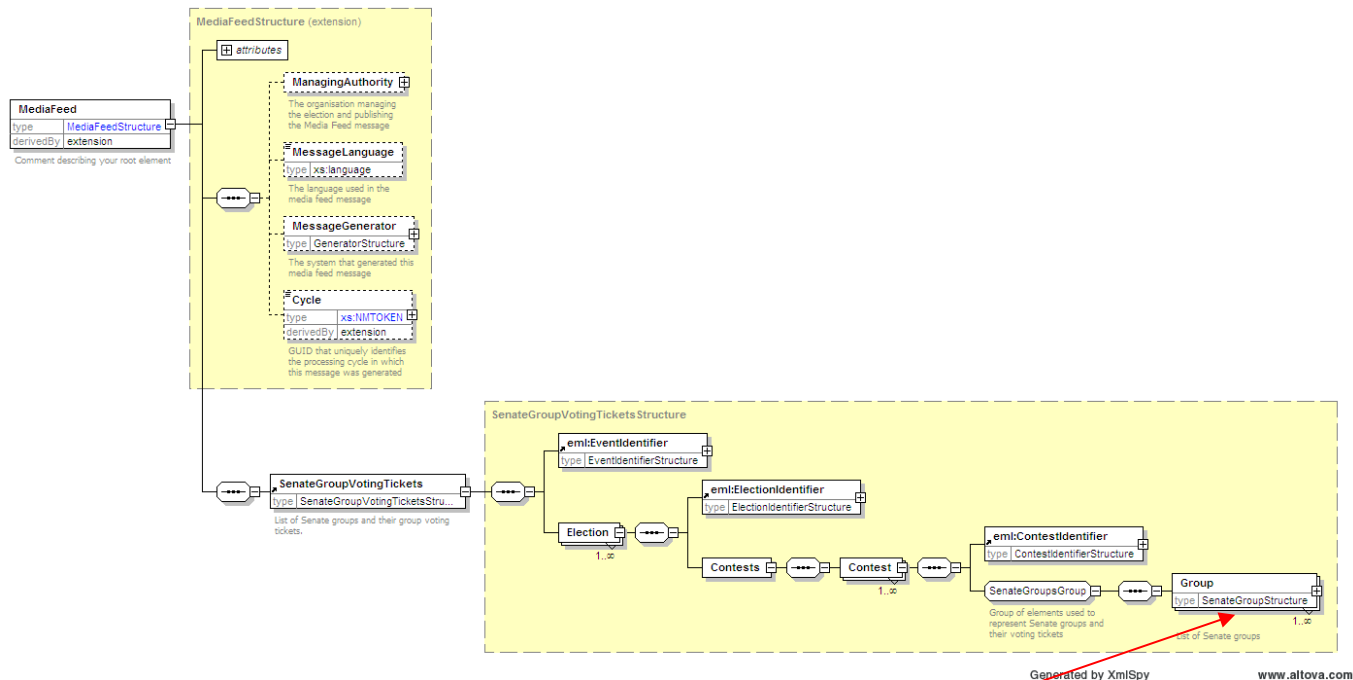

Continued Below

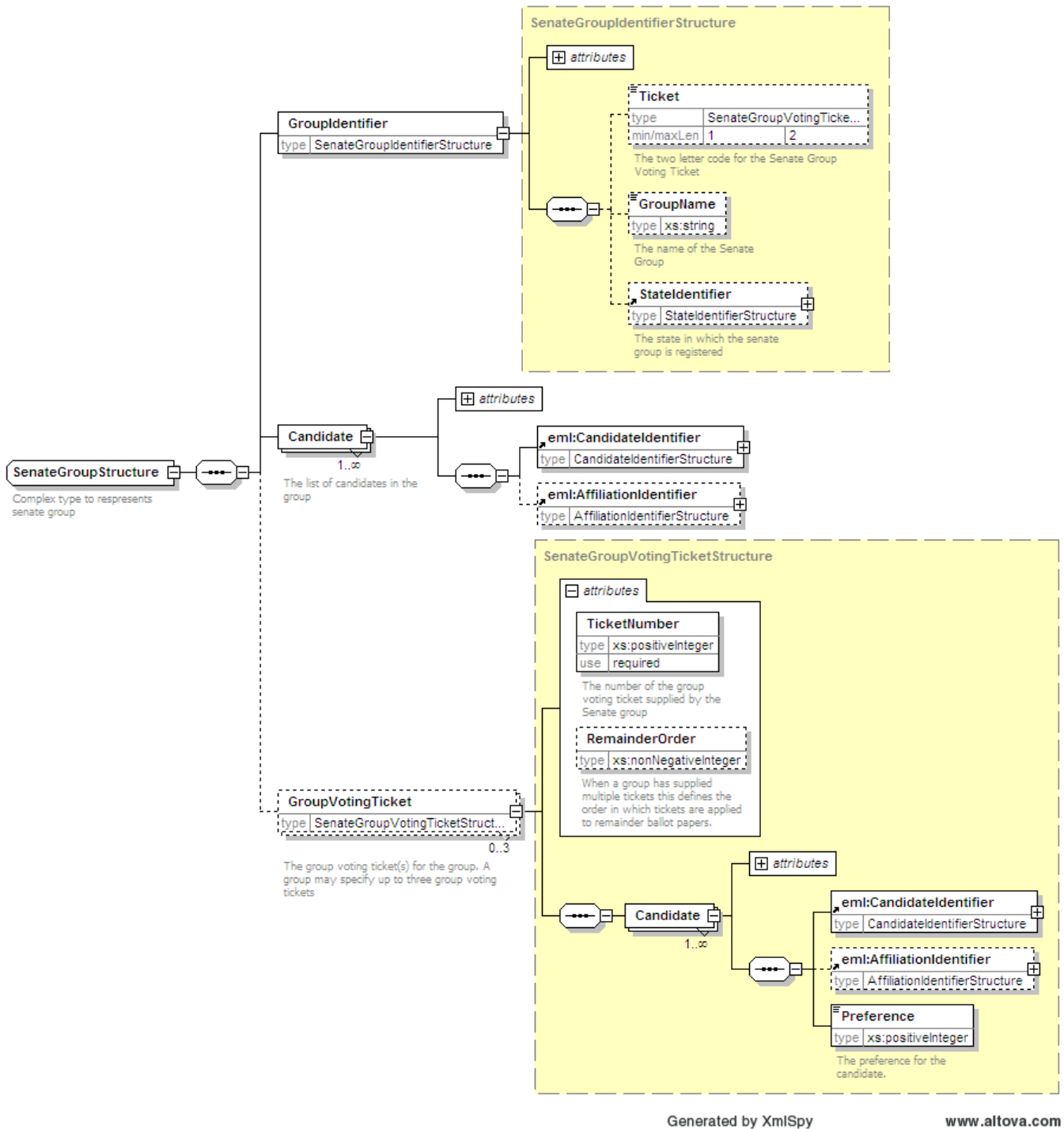

6.6.2 Example XML

An example of a partial Senate Groups message for the 2004 Federal Election is shown below.

```
<?xml version="1.0" encoding="utf-8"?>
<MediaFeed Id="ffb7eb99-37f6-4df8-86d7-b89c47566f40" Created="2006-12-20T17:05:25"
SchemaVersion="3" EmlVersion="5" xmlns="http://www.aec.gov.au/xml/schema/mediafeed"
xmlns:eml="urn:oasis:names:tc:evs:schema:eml"
xmlns:ds="http://www.w3.org/2000/09/xmldsig#"
```

```

xmlns:xal="urn:oasis:names:tc:ciq:xsd:schema:xAL:2.0"
xmlns:xnl="urn:oasis:names:tc:ciq:xsd:schema:xNL:2.0"
xmlns:ts="urn:oasis:names:tc:evs:schema:eml:ts"
xmlns:xs="http://www.w3.org/2001/XMLSchema-instance"
xs:schemaLocation="http://www.aec.gov.au/xml/schema/mediafeed ../Schema/AEC/aec-
mediafeed-groupvotingtickets-v3-0.xsd"
<ManagingAuthority>
  <eml:AuthorityIdentifier Id="AEC">Australian Electoral
Commission</eml:AuthorityIdentifier>
</ManagingAuthority>
<MessageLanguage>en</MessageLanguage>
<MessageGenerator>
  <Name>Virtual Tally Room</Name>
  <Environment>DEV</Environment>
  <Site>PARKES</Site>
  <Server>DEV01</Server>
  <Platform>x64</Platform>
  <Version>6.0.6.5754</Version>
</MessageGenerator>
<Cycle Created="2006-11-20T10:50:42">e28bc89e-180d-4520-9fcb-8c728d3d0864</Cycle>
<SenateGroupVotingTickets>
  <eml:EventIdentifier Id="12246">
    <eml:EventName>2004 Federal Election</eml:EventName>
  </eml:EventIdentifier>
  <Election>
    <eml:ElectionIdentifier Id="S">
      <eml:ElectionName>Senate Election</eml:ElectionName>
      <eml:ElectionCategory>Senate</eml:ElectionCategory>
    </eml:ElectionIdentifier>
    <Contests>
      <Contest>
        <eml:ContestIdentifier Id="ACT">
          <eml:ContestName>Australian Capital Territory</eml:ContestName>
        </eml:ContestIdentifier>
        <Group>
          <GroupIdentifier Id="628">
            <Ticket>A</Ticket>
            <GroupName>Australian Progressive Alliance</GroupName>
          </GroupIdentifier>
          <Candidate>
            <eml:CandidateIdentifier Id="14279">
              <eml:CandidateName>JOLLEY, Jeannette</eml:CandidateName>
            </eml:CandidateIdentifier>
            <eml:AffiliationIdentifier Id="1126" ShortCode="APA">
              <eml:RegisteredName>Australian Progressive
Alliance</eml:RegisteredName>
            </eml:AffiliationIdentifier>
          </Candidate>
          <Candidate>
            <eml:CandidateIdentifier Id="14284">
              <eml:CandidateName>DEEBANK, Ryan</eml:CandidateName>
            </eml:CandidateIdentifier>
            <eml:AffiliationIdentifier Id="1126" ShortCode="APA">
              <eml:RegisteredName>Australian Progressive
Alliance</eml:RegisteredName>
            </eml:AffiliationIdentifier>
          </Candidate>
          <GroupVotingTicket TicketNumber="1">
            <Candidate>
              <eml:CandidateIdentifier Id="14279">
                <eml:CandidateName>JOLLEY, Jeannette</eml:CandidateName>
              </eml:CandidateIdentifier>
              <eml:AffiliationIdentifier Id="1126" ShortCode="APA">
                <eml:RegisteredName>Australian Progressive
Alliance</eml:RegisteredName>
              </eml:AffiliationIdentifier>
            </Candidate>
            <Candidate>
              <eml:CandidateIdentifier Id="14284">
                <eml:CandidateName>DEEBANK, Ryan</eml:CandidateName>
              </eml:CandidateIdentifier>

```

```

        <eml:AffiliationIdentifier Id="1126" ShortCode="APA">
          <eml:RegisteredName>Australian Progressive
Alliance</eml:RegisteredName>
        </eml:AffiliationIdentifier>
        <Preference>2</Preference>
      </Candidate>
    </Candidate>
    <eml:CandidateIdentifier Id="15626">
      <eml:CandidateName>HUMPHRIES, Gary</eml:CandidateName>
    </eml:CandidateIdentifier>
    <eml:AffiliationIdentifier Id="177" ShortCode="LP">
      <eml:RegisteredName>Liberal Party of Australia - ACT
Division</eml:RegisteredName>
    </eml:AffiliationIdentifier>
    <Preference>10</Preference>
  </Candidate>
</Candidate>

```

6.6.3 Estimated Message Size

Electoral Event	XML File Size
General Election	3.5 MB
General Election including Referendum	3.5 MB
House of Representatives By-election	N/A
Referendum	N/A

6.7 Ballot Paper Message

This message contains an electronic definition of the Ballot Papers used during the election. It is primarily used to support electronic voting systems.

6.7.1 Message Schema

The message is based on the XML schema aec-mediafeed-ballotpapers-v3-0.xsd

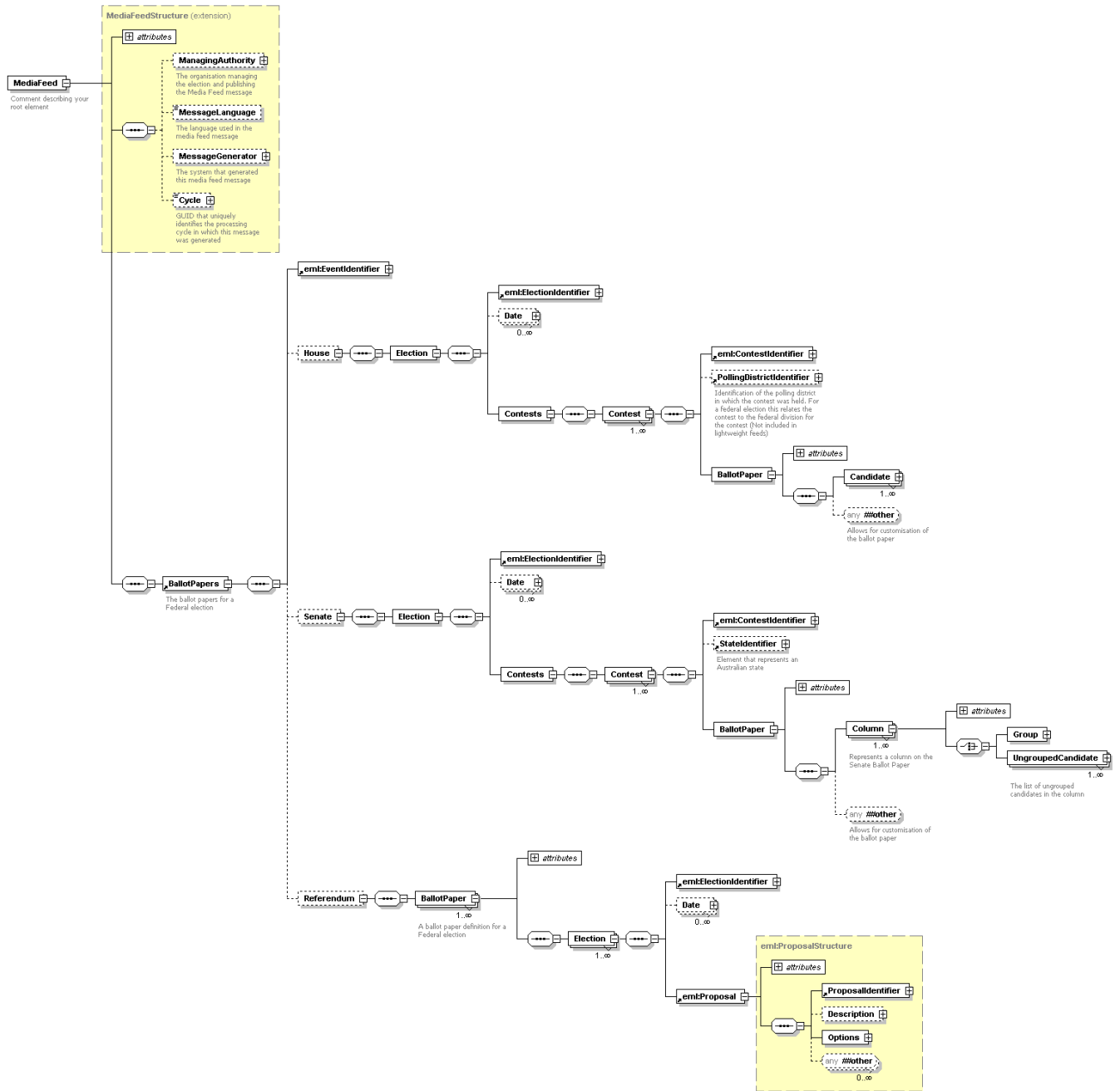

Generated by XmlSpy www.altova.com

6.7.2 Example XML

An example of a partial Ballot Paper message for the 2004 Federal Election is shown below.

```
<?xml version="1.0" encoding="utf-8"?>
<MediaFeed Id="38c50174-58f5-417d-9882-218fb38fdb8b" Created="2007-08-28T09:16:17"
SchemaVersion="3" EmlVersion="5" xmlns="http://www.aec.gov.au/xml/schema/mediafeed"
```

```

xmlns:eml="urn:oasis:names:tc:evs:schema:eml"
xmlns:ds="http://www.w3.org/2000/09/xmldsig#"
xmlns:xal="urn:oasis:names:tc:ciq:xsdschema:xAL:2.0"
xmlns:xnl="urn:oasis:names:tc:ciq:xsdschema:xNL:2.0"
xmlns:ts="urn:oasis:names:tc:evs:schema:eml:ts"
xmlns:xs="http://www.w3.org/2001/XMLSchema-instance"
xs:schemaLocation="http://www.aec.gov.au/xml/schema/mediafeed ../Schema/AEC/aec-
mediafeed-ballotpapers-v3-0.xsd"
<ManagingAuthority>
  <eml:AuthorityIdentifier Id="AEC">Australian Electoral
Commission</eml:AuthorityIdentifier>
</ManagingAuthority>
<MessageLanguage>en</MessageLanguage>
<MessageGenerator>
  <Name>Virtual Tally Room</Name>
  <Environment>DEV</Environment>
  <Site>PARKES</Site>
  <Server>DEV01</Server>
  <Platform>x64</Platform>
  <Version>6.0.6.5754</Version>
</MessageGenerator>
<Cycle Created="2007-08-28T07:20:07">b8ab9278-28da-43c5-b39e-64e07962220a</Cycle>
<BallotPapers>
  <eml:EventIdentifier Id="12246">
    <eml:EventName>2004 Federal Election</eml:EventName>
  </eml:EventIdentifier>
  <House>
    <Election>
      <eml:ElectionIdentifier Id="H">
        <eml:ElectionName>House of Representatives Election</eml:ElectionName>
        <eml:ElectionCategory>House</eml:ElectionCategory>
      </eml:ElectionIdentifier>
      <Date Type="PollingDay">
        <eml:SingleDate>2004-10-09T00:00:00</eml:SingleDate>
      </Date>
      <Contests>
        <Contest>
          <eml:ContestIdentifier Id="101">
            <eml:ContestName>Canberra</eml:ContestName>
          </eml:ContestIdentifier>
          <PollingDistrictIdentifier Id="101" ShortCode="CANB">
            <Name>Canberra</Name>
            <StateIdentifier Id="ACT" />
          </PollingDistrictIdentifier>
          <BallotPaper Id="101">
            <Candidate>
              <eml:CandidateIdentifier Id="15421">
                <eml:CandidateName>ELLERMAN, Sue</eml:CandidateName>
              </eml:CandidateIdentifier>
              <eml:AffiliationIdentifier Id="37" ShortCode="GRN">
                <eml:RegisteredName>The Greens</eml:RegisteredName>
              </eml:AffiliationIdentifier>
              <BallotPosition>1</BallotPosition>
            </Candidate>
          </BallotPaper>
        </Contest>
      </Contests>
    </Election>
  </House>
</eml:EventIdentifier>
</BallotPapers>

```

6.7.3 Estimated Message Size

Electoral Event	XML File Size
General Election	750 KB
General Election including Referendum	1 MB
House of Representatives By-election	N/A
Referendum	N/A

7. Results Messages

Results messages provide a progressive update of results throughout the election period.

7.1 AEC Results Message

7.1.1 Overview

EML does not have a specific message schema for reporting progressive results. Therefore, the AEC uses a custom message for this purpose. In the AEC Media Feed System this message is used to package the following information.

- Progress of the count (polling places in, votes counted, declared, etc.)
- House Candidate First Preference Results
- House Two Candidate Preferred Results
- House Two Party Preferred Results
- Senate Quota
- Senate Candidate and Group First Preference Results
- Referendum Results
- Historic and matched historic votes

7.1.2 Message Granularity

7.1.2.1 Standard Granularity

The standard granularity message contains significantly less information and is significantly smaller than the detailed message. The Standard granularity results message services the needs of most users.

7.1.2.2 Detailed Granularity

The detailed granularity Results message contains significantly more information and is much larger in size than the standard granularity Results message. The detailed granularity Results message will be used by those organisations that have specialised requirements or complex predictive and analytical IT systems.

7.1.2.3 Comparison Matrix

Results	Standard	Detailed
House candidate results at the Division level	Y	Y
House candidate results at the Polling Place level	N	Y*
Senate candidate and group results at the State level	Y	Y
Referendum proposal results at the Division level	Y	Y

*** Please Note:** The Detailed Light Progress Results message contains count progress information at the polling place level however it does not contain candidate results at the polling place level.

7.1.3 Message Verbosity

The AEC Results message is generated in four different verbosity levels, all of which validate against the same XML schema.

7.1.3.1 Verbose

This message contains complete House of Representatives, Senate and Referendum election results. The message includes vote counts; candidate names and party details; division information; enrolment; count progress; historic results, aggregations and calculations such as percentages and swings.

7.1.3.2 Light

This message contains a minimal set of House of Representatives, Senate and Referendum election results. The message does not contain candidate names, Party details, historic votes, calculations or aggregations. This message is designed to be used in conjunction with the Preload Results message which is processed prior to the election period.

7.1.3.3 LightProgress

This message contains a minimal set of House of Representatives, Senate and Referendum election results. The message does not contain candidate names, parties details, historic votes, calculations or aggregations. Where appropriate it contains count progress at the polling place level. This message is designed to be used in conjunction with the Preload Results message which is processed prior to the election period.

7.1.3.4 Comparison Matrix

Data	Verbose	Preload	Light	Light Progress
Candidate ID	Y	Y	Y	Y
Candidate Names	Y	Y	N	N
Candidate Party ID	Y	Y	Y	Y
Candidate Party Name	Y	Y	N	N
Ballot Position	Y	Y	Y	Y
Historic Votes	Y	Y	N	N
Matched Historic Votes	Y	Y	Y	Y
Votes	Y	Y	Y	Y
Vote calculations like percentages and swing	Y	Y	N	N
Vote aggregations to state and national level by party	Y	Y	N	N

7.1.4 Schema

The message is based on the XML schema aec-mediafeed-results-v3-0.xsd

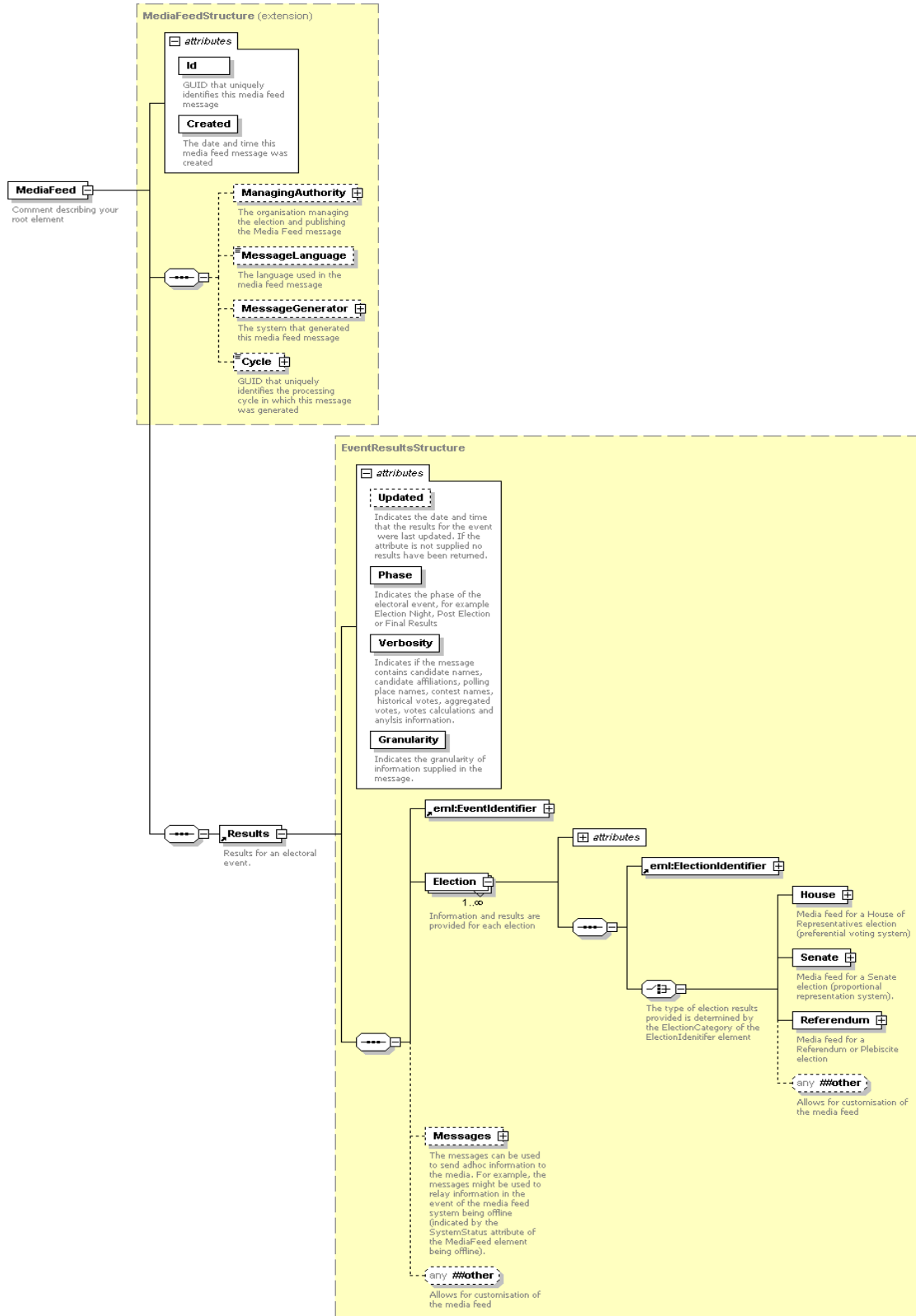

7.1.4.1 VotesStructure Complex Type

Any element that represents votes in the following diagrams uses the following complex type

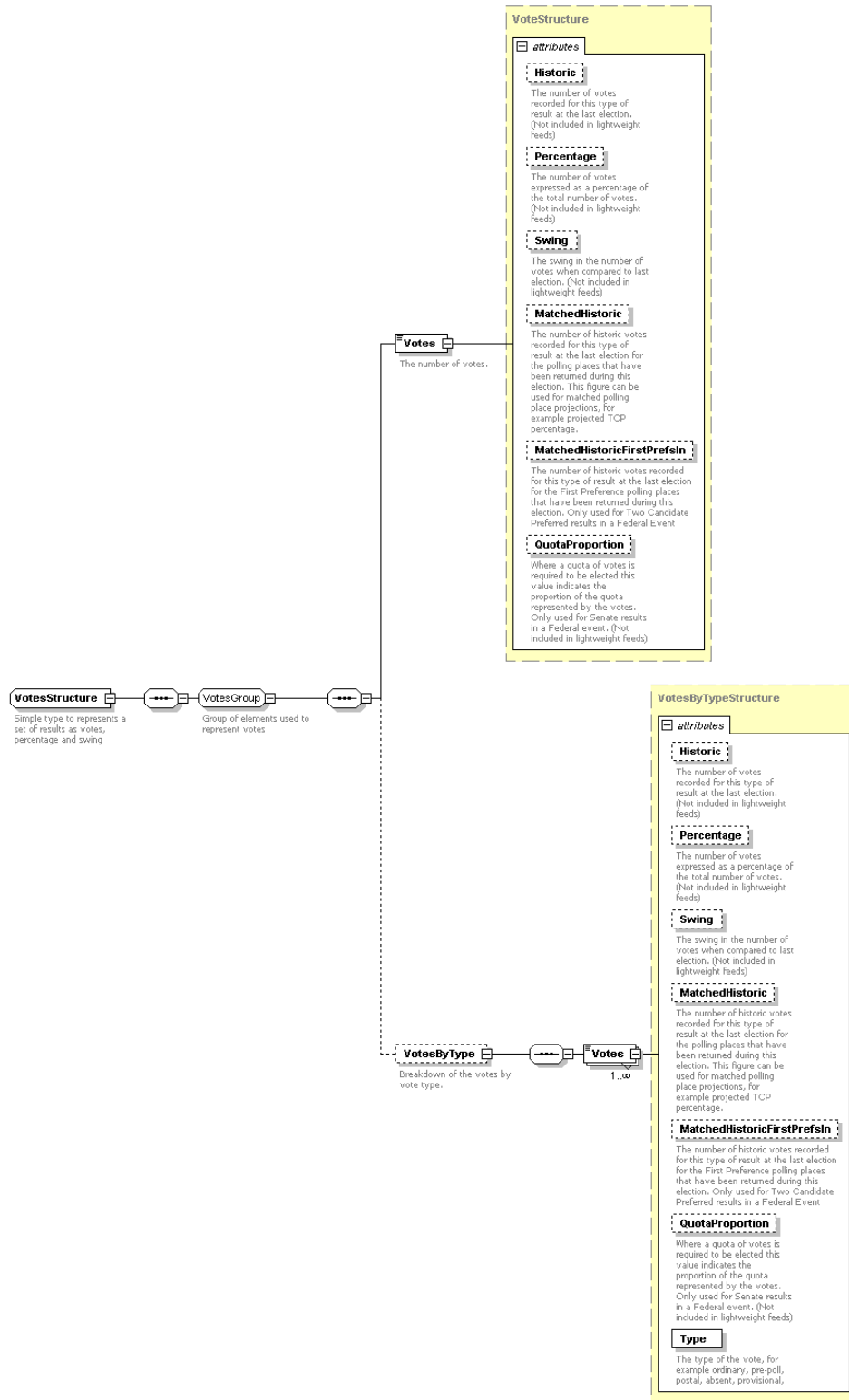

7.1.4.2 House Element

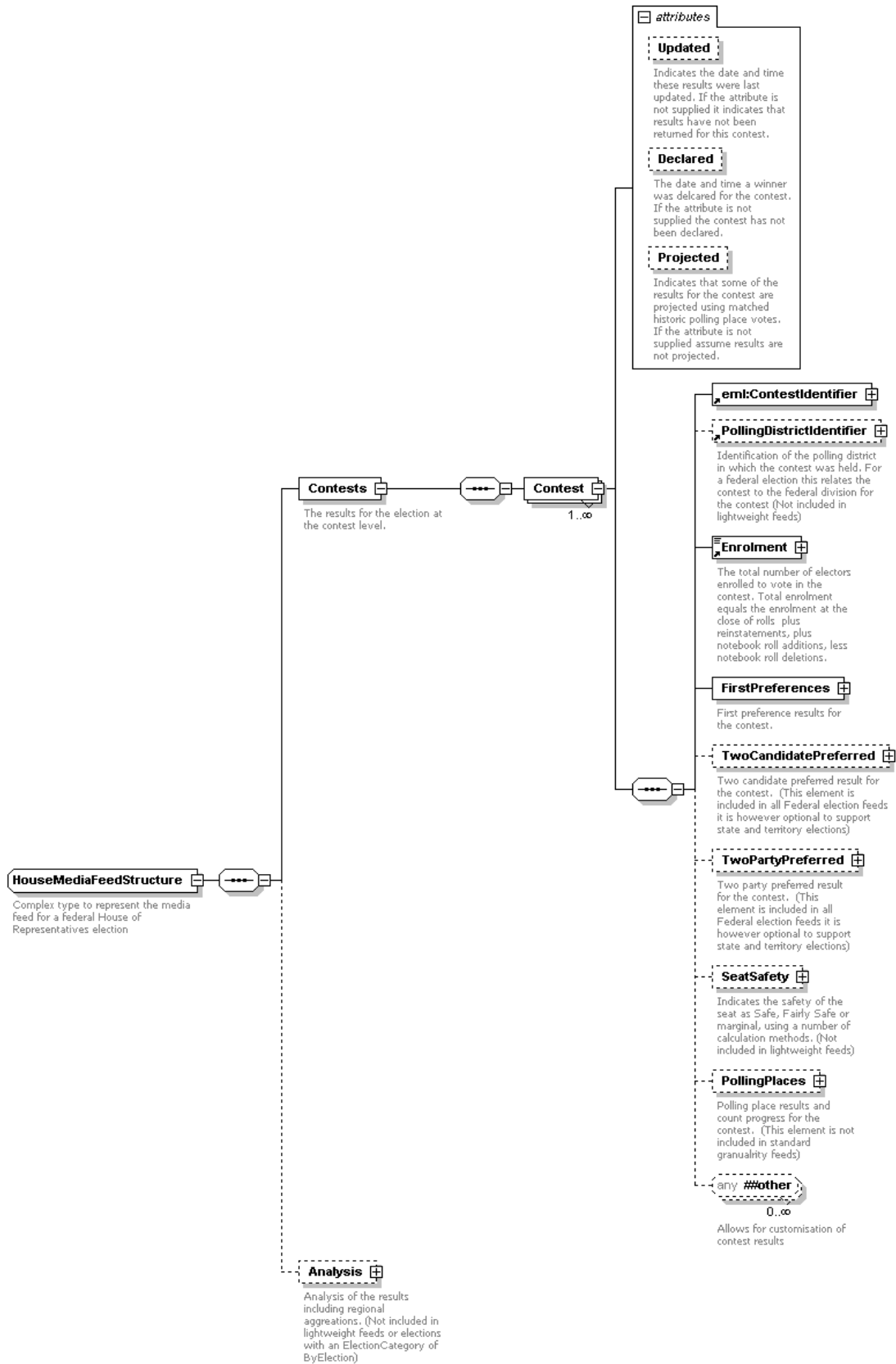

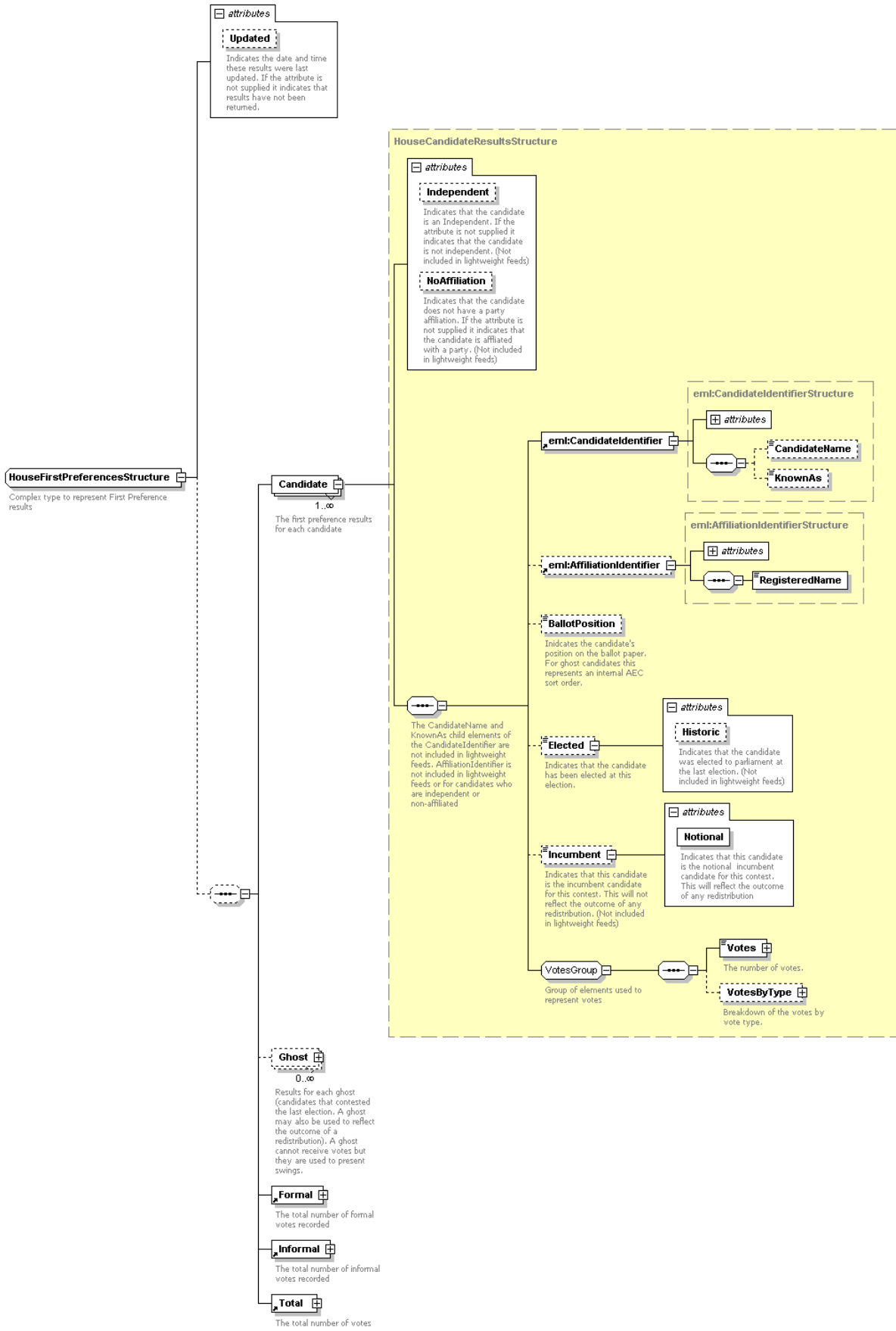

TwoCandidatePreferredStructure

Complex type to represent TCP results

attributes

Updated
Indicates the date and time these results were last updated. If the attribute is not supplied it indicates that results have not been returned.

Restricted
Indicates that the Two Candidate Preferred results are restricted at this time and are unavailable. The AEC does not release the TCP candidates until 6:00pm election night. Before this time all TCP results are restricted. If the attribute is not supplied it indicates that results are not restricted.

Maverick
Indicates that the incorrect candidates have been selected for the two candidate preferred count. In this case no TCP results are available. If the attribute is not supplied it indicates that results are not maverick.

Candidate 2

The Two Candidate Preferred results is only included when both the Maverick attribute is false and the Restricted attribute is false.

Please note: CandidateName, KnownAs and AffiliationIdentifier are not included in lightweight feeds.

HouseCandidateResultsStructure

attributes

eml:CandidateIdentifier

eml:AffiliationIdentifier

BallotPosition
Indicates the candidate's position on the ballot paper. For ghost candidates this represents an internal AEC sort order.

Elected
Indicates that the candidate has been elected at this election.

Incumbent
Indicates that this candidate is the incumbent candidate for this contest. This will not reflect the outcome of any redistribution. (Not included in lightweight feeds)

VotesGroup
Group of elements used to represent votes

Votes
The number of votes.

VotesByType
Breakdown of the votes by vote type.

The CandidateName and KnownAs child elements of the CandidateIdentifier are not included in lightweight feeds. AffiliationIdentifier is not included in lightweight feeds or for candidates who are independent or non-affiliated

Generated by XmlSpy

www.altova.com

7.1.4.3 Senate Element

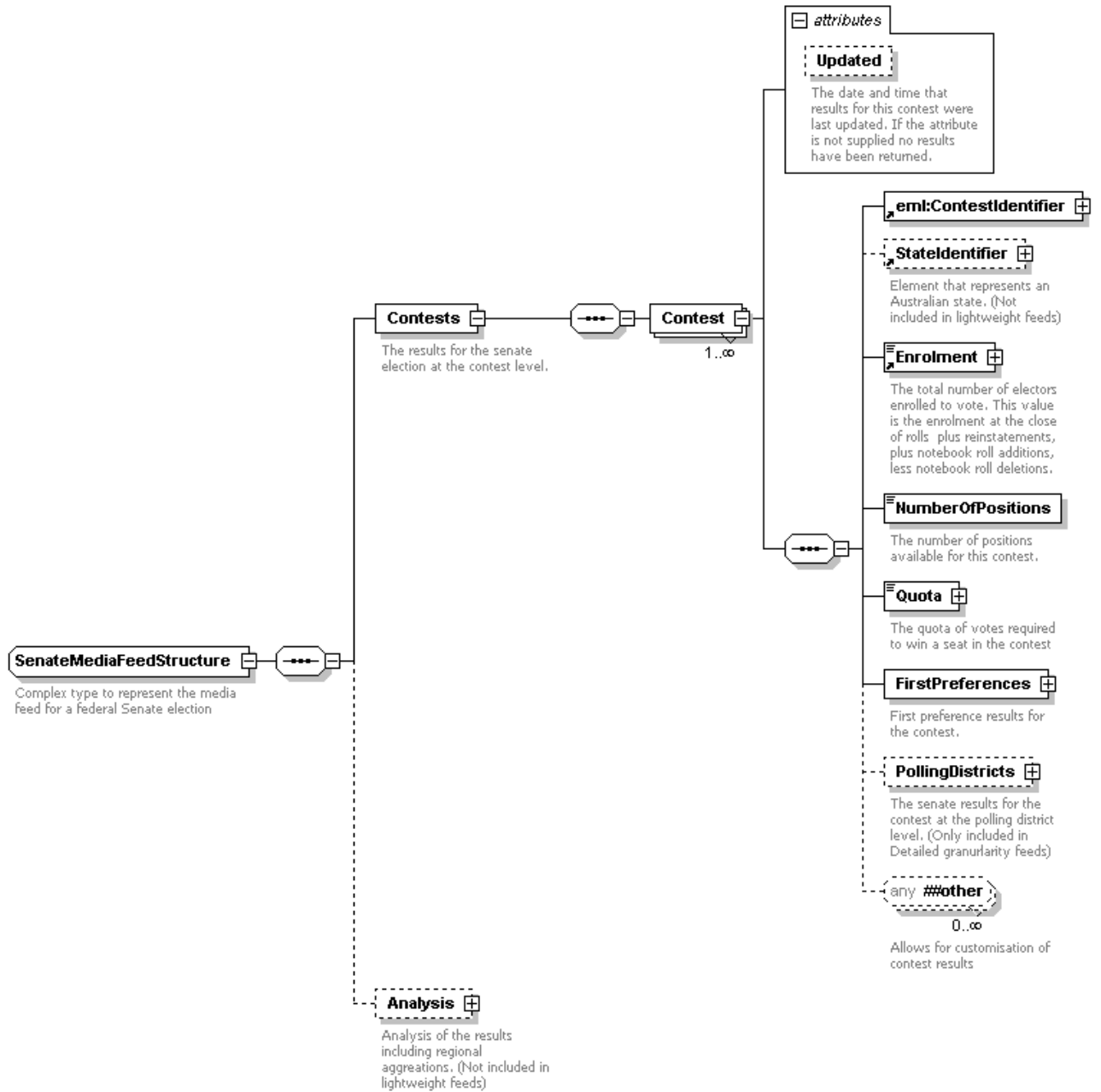

Generated by XmlSpy

www.altova.com

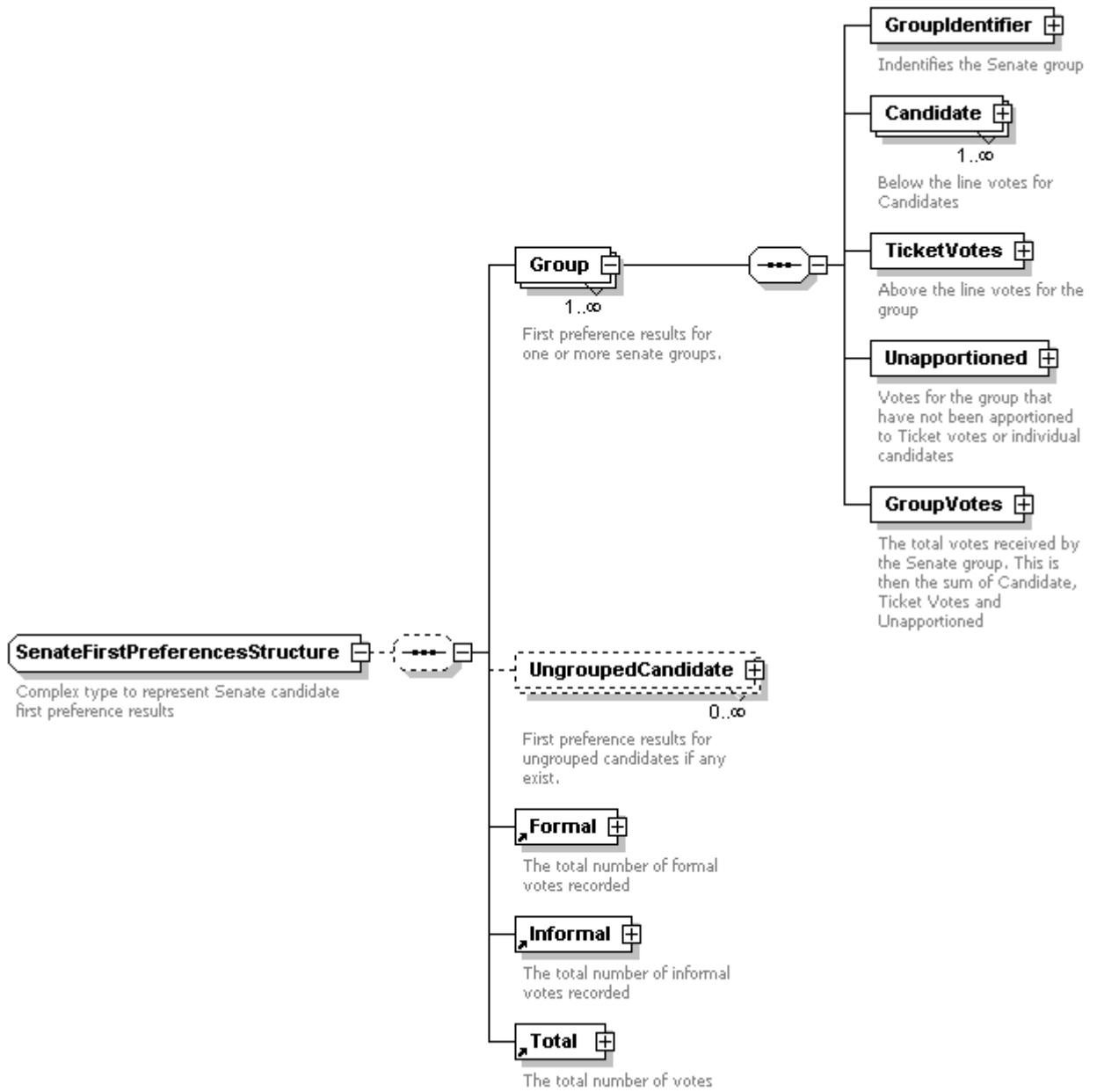

Generated by XmlSpy

www.altova.com

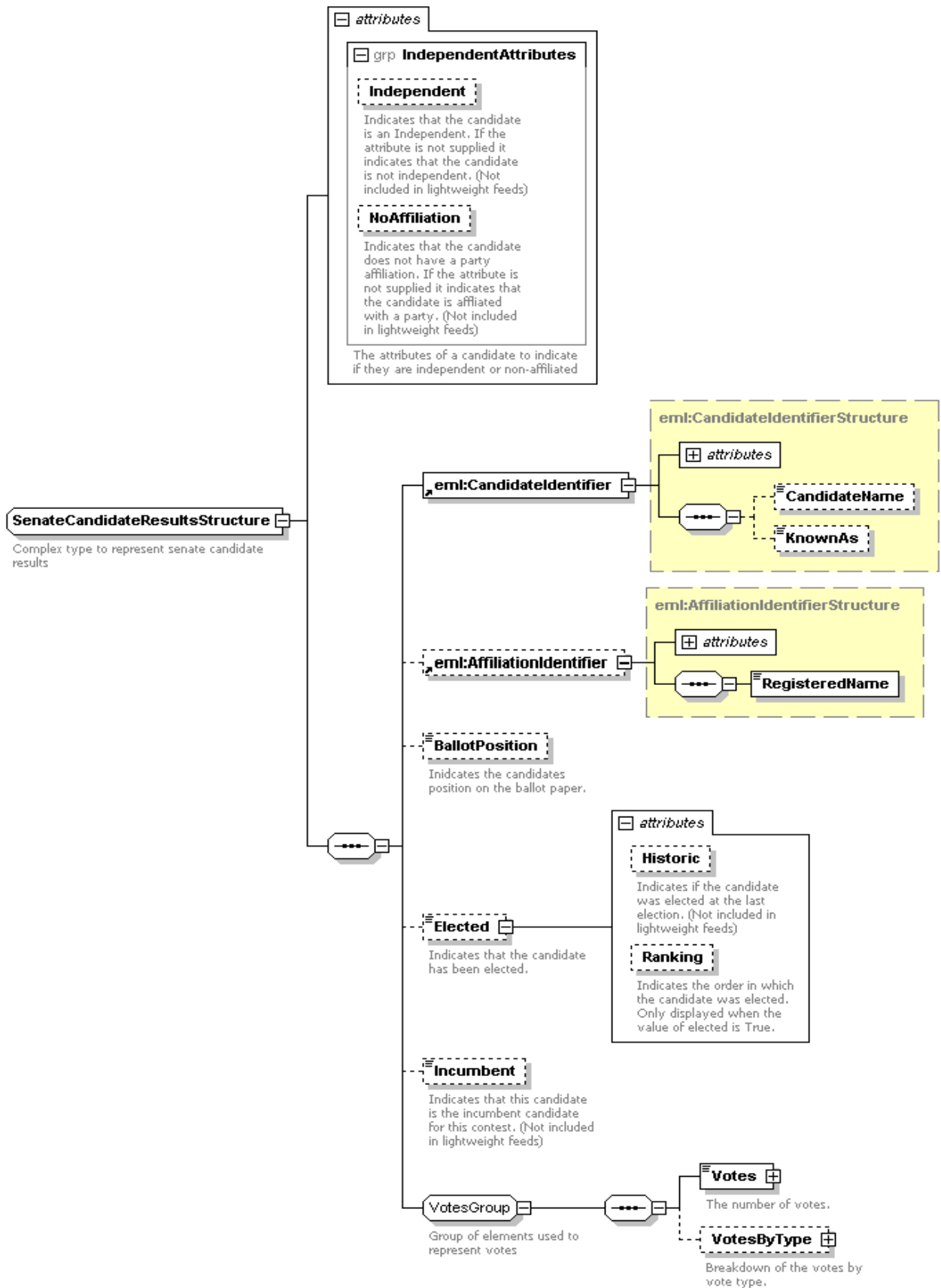

7.1.4.4 Referendum Media Feed Element

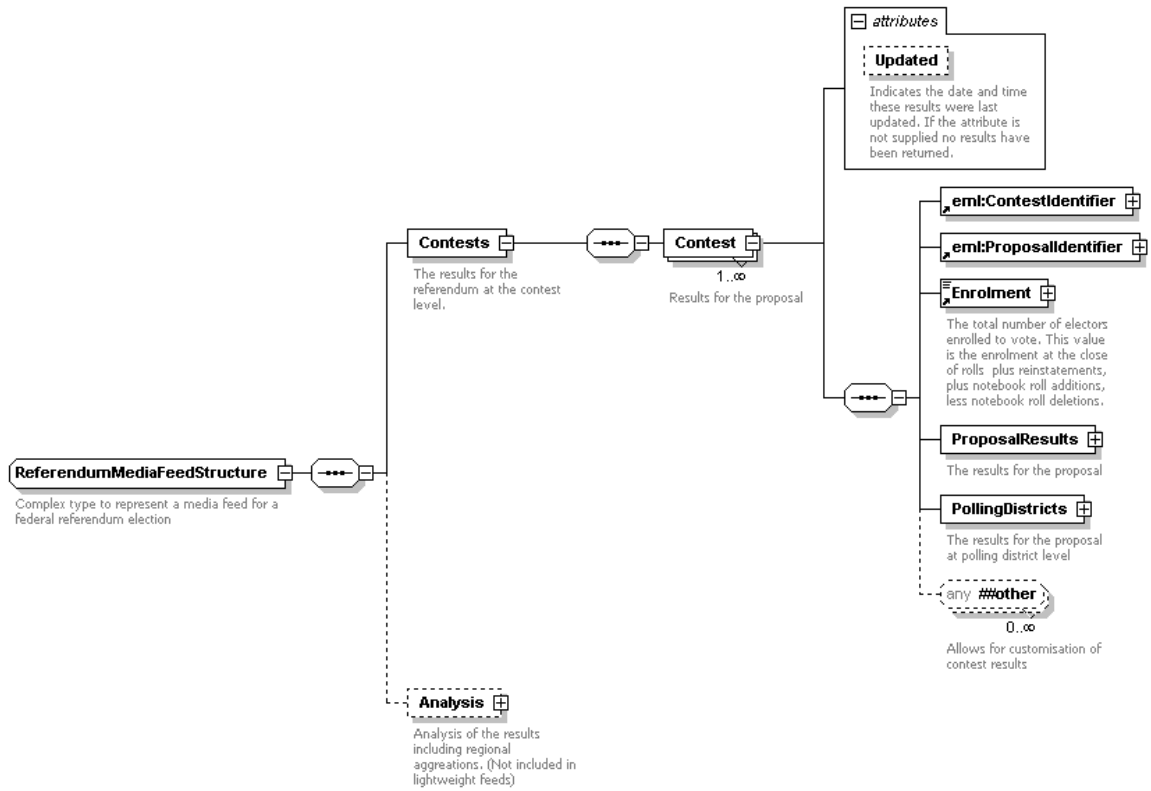

Generated by XmlSpy

www.altova.com

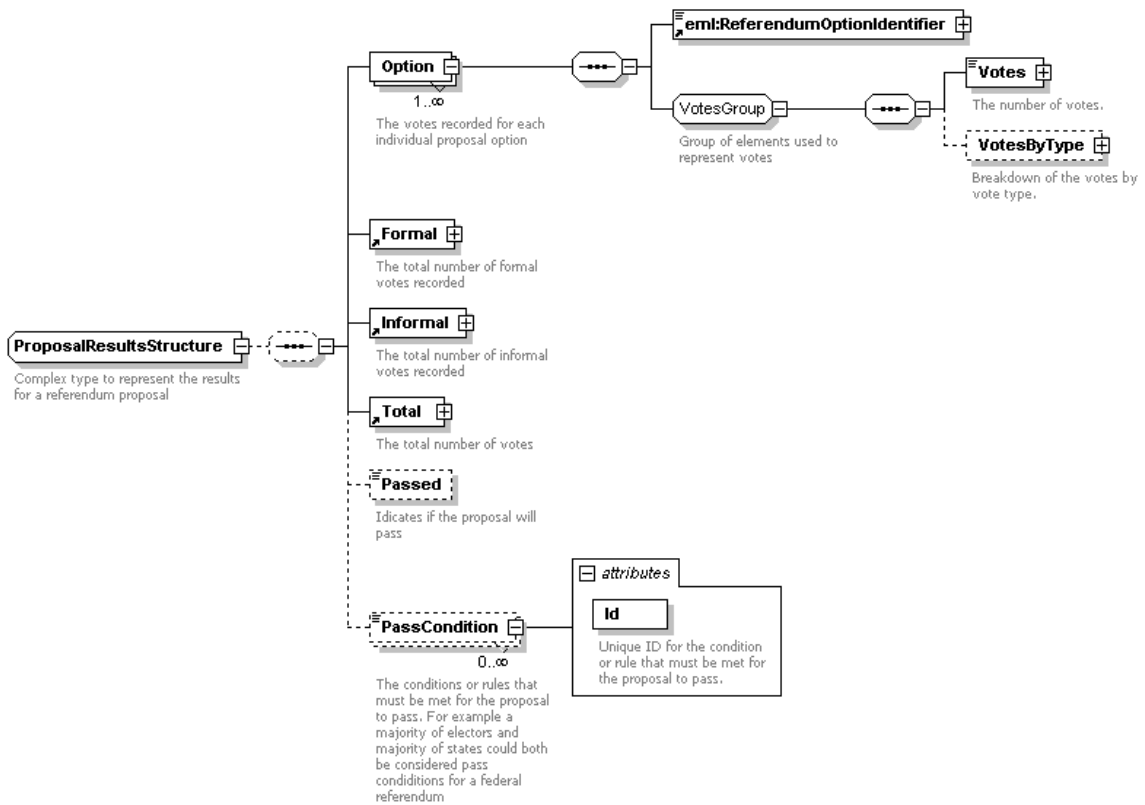

Generated by XmlSpy

www.altova.com

7.1.5 Example XML

7.1.5.1 Verbose

```
<?xml version="1.0" encoding="utf-8"?>
<MediaFeed Id="81eb418f-ed04-4e1b-8930-53df6fa979e4" Created="2006-12-20T17:05:48"
SchemaVersion="3" EmlVersion="5" xmlns="http://www.aec.gov.au/xml/schema/mediafeed"
xmlns:eml="urn:oasis:names:tc:evs:schema:eml"
xmlns:ds="http://www.w3.org/2000/09/xmldsig#"
xmlns:xal="urn:oasis:names:tc:ciq:xsd:schema:xAL:2.0"
xmlns:xnl="urn:oasis:names:tc:ciq:xsd:schema:xNL:2.0"
xmlns:ts="urn:oasis:names:tc:evs:schema:eml:ts"
xmlns:xs="http://www.w3.org/2001/XMLSchema-instance"
xs:schemaLocation="http://www.aec.gov.au/xml/schema/mediafeed ../Schema/AEC/aec-
mediafeed-results-v3-0.xsd">
  <ManagingAuthority>
    <eml:AuthorityIdentifier Id="AEC">Australian Electoral
Commission</eml:AuthorityIdentifier>
  </ManagingAuthority>
  <MessageLanguage>en</MessageLanguage>
  <MessageGenerator>
    <Name>Virtual Tally Room</Name>
    <Environment>DEV</Environment>
    <Site>PARKES</Site>
    <Server>DEV01</Server>
    <Platform>x64</Platform>
    <Version>6.0.6.5754</Version>
  </MessageGenerator>
  <Cycle Created="2006-11-20T10:50:42">e28bc89e-180d-4520-9fcb-8c728d3d0864</Cycle>
  <Results Updated="2004-12-10T15:35:46" Phase="Preload" Verbosity="Verbose"
Granularity="Detailed">
    <eml:EventIdentifier Id="12246">
      <eml:EventName>2004 Federal Election</eml:EventName>
    </eml:EventIdentifier>
    <Election Updated="2004-11-26T14:36:56">
```

```

<eml:ElectionIdentifier Id="H">
  <eml:ElectionName>House of Representatives Election</eml:ElectionName>
  <eml:ElectionCategory>House</eml:ElectionCategory>
</eml:ElectionIdentifier>
<House>
  <Contests>
    <Contest Updated="2004-10-26T11:01:59" Declared="2004-10-28T00:00:00">
      <eml:ContestIdentifier Id="101">
        <eml:ContestName>Canberra</eml:ContestName>
      </eml:ContestIdentifier>
      <PollingDistrictIdentifier Id="101" ShortCode="CANB">
        <Name>Canberra</Name>
        <StateIdentifier Id="ACT" />
      </PollingDistrictIdentifier>
      <Enrolment CloseOfRolls="108369" Historic="108959">109476</Enrolment>
      <FirstPreferences Updated="2004-10-26T11:25:05"
PollingPlacesReturned="39" PollingPlacesExpected="39">
        <Candidate>
          <eml:CandidateIdentifier Id="15421">
            <eml:CandidateName>ELLERMAN, Sue</eml:CandidateName>
          </eml:CandidateIdentifier>
          <eml:AffiliationIdentifier Id="37" ShortCode="GRN">
            <eml:RegisteredName>The Greens</eml:RegisteredName>
          </eml:AffiliationIdentifier>
          <BallotPosition>1</BallotPosition>
          <Elected Historic="false">>false</Elected>
          <Incumbent Notional="false">>false</Incumbent>
          <Votes Historic="0" Percentage="10.17" Swing="3.92"
MatchedHistoric="6268">10243</Votes>
          <VotesByType>
            <Votes Type="Ordinary" Historic="0" Percentage="9.82"
Swing="3.66">7687</Votes>
            <Votes Type="Absent" Historic="0" Percentage="16.24"
Swing="5.21">336</Votes>
            <Votes Type="Provisional" Historic="0" Percentage="13.99"
Swing="8.1">141</Votes>
            <Votes Type="PrePoll" Historic="0" Percentage="10.88"
Swing="4.78">1713</Votes>
            <Votes Type="Postal" Historic="0" Percentage="10.19"
Swing="5.3">366</Votes>
          </VotesByType>
        </Candidate>

```

7.1.5.2 Light

```

<?xml version="1.0" encoding="utf-8"?>
<MediaFeed Id="c8c7e5cb-fdc3-4e6b-a8f5-0e7b50878b9f" Created="2006-12-20T17:05:48"
SchemaVersion="3" EmIVersion="5" xmlns="http://www.aec.gov.au/xml/schema/mediafeed"
xmlns:eml="urn:oasis:names:tc:evs:schema:eml"
xmlns:ds="http://www.w3.org/2000/09/xmldsig#"
xmlns:xal="urn:oasis:names:tc:ciq:xsd:schema:xAL:2.0"
xmlns:xnl="urn:oasis:names:tc:ciq:xsd:schema:xNL:2.0"
xmlns:ts="urn:oasis:names:tc:evs:schema:eml:ts"
xmlns:xs="http://www.w3.org/2001/XMLSchema-instance"
xs:schemaLocation="http://www.aec.gov.au/xml/schema/mediafeed ../Schema/AEC/aec-
mediafeed-results-v3-0.xsd">
  <ManagingAuthority>
    <eml:AuthorityIdentifier Id="AEC">Australian Electoral
Commission</eml:AuthorityIdentifier>
  </ManagingAuthority>
  <MessageLanguage>en</MessageLanguage>
  <MessageGenerator>
    <Name>Virtual Tally Room</Name>
    <Environment>DEV</Environment>
    <Site>PARKES</Site>
    <Server>DEV01</Server>
    <Platform>x64</Platform>
    <Version>6.0.6.5754</Version>
  </MessageGenerator>
  <Cycle Created="2006-11-20T10:50:42">e28bc89e-180d-4520-9fcb-8c728d3d0864</Cycle>

```

```

<Results Updated="2004-12-10T15:35:46" Phase="Preload" Verbosity="Light"
Granularity="Standard">
  <eml:EventIdentifier Id="12246">
    <eml:EventName>2004 Federal Election</eml:EventName>
  </eml:EventIdentifier>
  <Election Updated="2004-11-26T14:36:56">
    <eml:ElectionIdentifier Id="H">
      <eml:ElectionName>House of Representatives Election</eml:ElectionName>
      <eml:ElectionCategory>House</eml:ElectionCategory>
    </eml:ElectionIdentifier>
    <House>
      <Contests>
        <Contest Updated="2004-10-26T11:01:59" Declared="2004-10-28T00:00:00">
          <eml:ContestIdentifier Id="101">
            <eml:ContestName>Canberra</eml:ContestName>
          </eml:ContestIdentifier>
          <Enrolment>109476</Enrolment>
          <FirstPreferences Updated="2004-10-26T11:25:05"
PollingPlacesReturned="39" PollingPlacesExpected="39">
            <Candidate>
              <eml:CandidateIdentifier Id="15421" />
              <BallotPosition>1</BallotPosition>
              <Elected>>false</Elected>
              <Votes MatchedHistoric="6268">10243</Votes>
              <VotesByType>
                <Votes Type="Ordinary">7687</Votes>
                <Votes Type="Absent">336</Votes>
                <Votes Type="Provisional">141</Votes>
                <Votes Type="PrePoll">1713</Votes>
                <Votes Type="Postal">366</Votes>
              </VotesByType>
            </Candidate>

```

7.1.5.3 LightProgress

```

  <PollingPlaces>
    <PollingPlace Updated="2004-10-25T13:38:24">
      <PollingPlaceIdentifier Id="11877" />
      <FirstPreferences Updated="2004-10-25T13:38:24" />
      <TwoCandidatePreferred Updated="2004-10-25T13:38:24"
Restricted="true" />
    </PollingPlace>
    <PollingPlace Updated="2004-10-18T19:17:45">
      <PollingPlaceIdentifier Id="11452" />
      <FirstPreferences Updated="2004-10-18T19:17:45" />
      <TwoCandidatePreferred Updated="2004-10-18T19:17:45"
Restricted="true" />
    </PollingPlace>
    <PollingPlace Updated="2004-10-18T19:18:42">
      <PollingPlaceIdentifier Id="8794" />
      <FirstPreferences Updated="2004-10-18T19:18:42" />
      <TwoCandidatePreferred Updated="2004-10-18T19:18:42"
Restricted="true" />
    </PollingPlace>

```

7.1.6 Estimated Message Size

7.1.6.1 Verbose

Electoral Event	Standard	Detailed
General Election	2.5 MB	17MB
General Election including Referendum (2 Questions)	12 MB	18 KB
House of Representatives By-election	50 KB	75 KB
Referendum (2 Questions)	650 MB	650 KB

7.1.6.2 Preload

Electoral Event	Standard	Detailed
General Election	2.5 MB	17MB
General Election including Referendum (2 Questions)	12 MB	18 KB
House of Representatives By-election	50 KB	75 KB
Referendum (2 Questions)	650 MB	650 KB

7.1.6.3 Light

Electoral Event	Standard	Detailed
General Election	1.1 MB	9.7 MB
General Election including Referendum (2 Questions)	1.5 MB	10.5 MB
House of Representatives By-election	25 KB	50 KB
Referendum (2 Questions)	450 MB	450 KB

7.1.6.4 LightProgress

Electoral Event	Standard	Detailed
General Election	N/A	2.7MB
General Election including Referendum (2 Questions)	N/A	3.2 MB
House of Representatives By-election	N/A	40 KB
Referendum (2 Questions)	N/A	450 KB

7.2 EML Count Message (EML 510)

7.2.1 Overview

This message is used to communicate the vote counts for an electoral event using the EML standard. This message shows the current first preference votes for candidates and/or referendum options.

7.2.2 Message Schema

The message is based on the XML schema in the file 510-count-v5-0.xsd

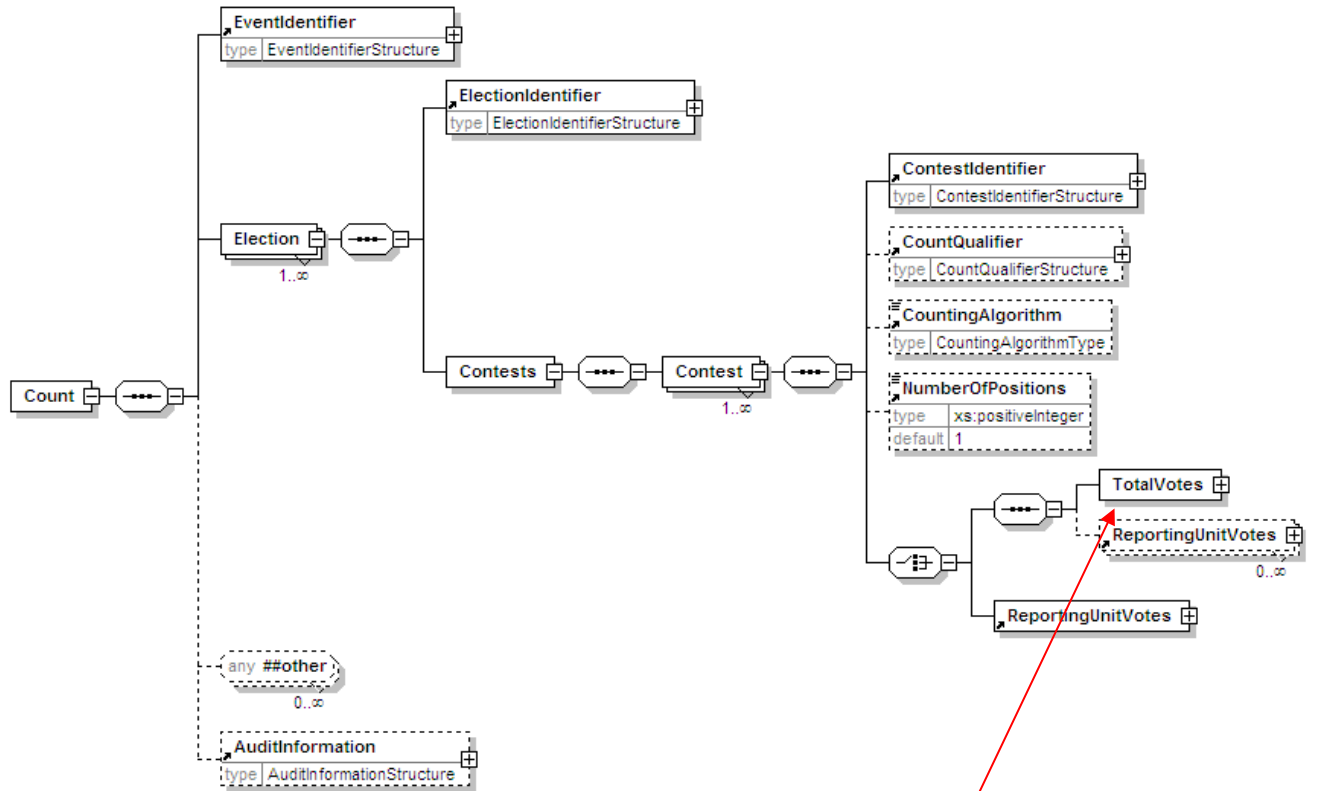

Generated by XmlSpy

www.altova.com

Continued Below

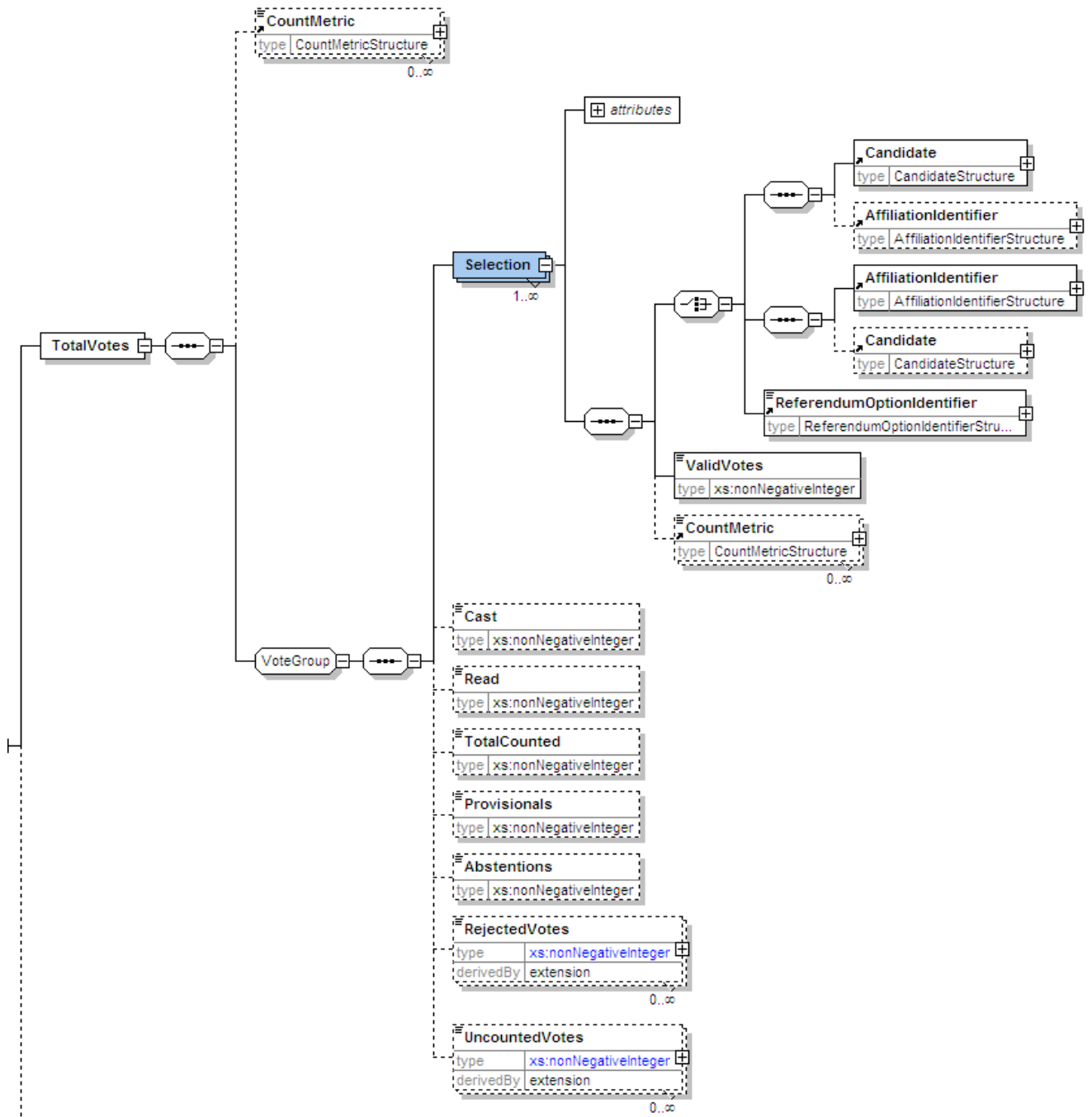

7.2.3 Example XML

A portion of the EML Count message for the 2007 Federal Election is shown below.

```
?xml version="1.0" encoding="utf-8"?>
<EML xmlns="urn:oasis:names:tc:evs:schema:eml"
xmlns:ds="http://www.w3.org/2000/09/xmldsig#"
xmlns:xal="urn:oasis:names:tc:ciq:xsd:schema:xAL:2.0"
xmlns:xnl="urn:oasis:names:tc:ciq:xsd:schema:xNL:2.0"
xmlns:ts="urn:oasis:names:tc:evs:schema:eml:ts"
xmlns:xs="http://www.w3.org/2001/XMLSchema-instance"
xs:schemaLocation="urn:oasis:names:tc:evs:schema:eml ../Schema/EML/510-count-v5-
0.xsd" SchemaVersion="5" Id="5a95a7c3-a870-41da-9a89-cc7c4c45c9ea">
```

```

<TransactionId>7dc03687-2b41-47f5-b4a6-b0bf4ca60bcf</TransactionId>
<Count>
  <EventIdentifier Id="13745">
    <EventName>2007 Federal Election</EventName>
  </EventIdentifier>
  <Election>
    <ElectionIdentifier Id="H">
      <ElectionName>House of Representatives Election</ElectionName>
      <ElectionCategory>House</ElectionCategory>
    </ElectionIdentifier>
    <Contests>
      <Contest>
        <ContestIdentifier Id="101" ShortCode="CANB">
          <ContestName>Canberra</ContestName>
        </ContestIdentifier>
        <NumberOfPositions>1</NumberOfPositions>
        <TotalVotes>
          <Selection>
            <Candidate>
              <CandidateIdentifier Id="17277">
                <CandidateName>BRESNAN, Amanda</CandidateName>
              </CandidateIdentifier>
            </Candidate>
            <AffiliationIdentifier Id="37" ShortCode="GRN">
              <RegisteredName>The Greens</RegisteredName>
            </AffiliationIdentifier>
            <ValidVotes>4910</ValidVotes>
          </Selection>
          <Selection>
            <Candidate>
              <CandidateIdentifier Id="18175">
                <CandidateName>COLBERT, Natalie</CandidateName>
              </CandidateIdentifier>
            </Candidate>
            <AffiliationIdentifier Id="177" ShortCode="LP">
              <RegisteredName>Liberal</RegisteredName>
            </AffiliationIdentifier>
            <ValidVotes>13387</ValidVotes>
          </Selection>
          <Selection>
            <Candidate>
              <CandidateIdentifier Id="17614">
                <CandidateName>ELLIS, Annette</CandidateName>
              </CandidateIdentifier>
            </Candidate>
            <AffiliationIdentifier Id="200" ShortCode="ALP">
              <RegisteredName>Australian Labor Party</RegisteredName>
            </AffiliationIdentifier>
            <ValidVotes>20165</ValidVotes>
          </Selection>
          <Selection>
            <Candidate>
              <CandidateIdentifier Id="17310">
                <CandidateName>HOLDER, John</CandidateName>
              </CandidateIdentifier>
            </Candidate>
            <AffiliationIdentifier Id="1181" ShortCode="CEC">
              <RegisteredName>Citizens Electoral Council</RegisteredName>
            </AffiliationIdentifier>
            <ValidVotes>341</ValidVotes>
          </Selection>
          <RejectedVotes ReasonCode="Informal">969</RejectedVotes>
        </TotalVotes>
      </Contest>
    </Contests>
  </Election>
</Count>

```

7.2.4 Estimated Message Size

Electoral Event	XML File Size
General Election	370 KB
General Election including Referendum	400 KB
House of Representatives By-election	7 KB
Referendum	3 KB

7.3 EML Result Message (EML 520)

7.3.1 Overview

This message is used to communicate the result of an election using the EML standard. This message indicates which candidates have been elected and which referendum options have been passed.

7.3.2 Message Schema

The message is based on the XML schema in the file 520-result-v5-0.xsd

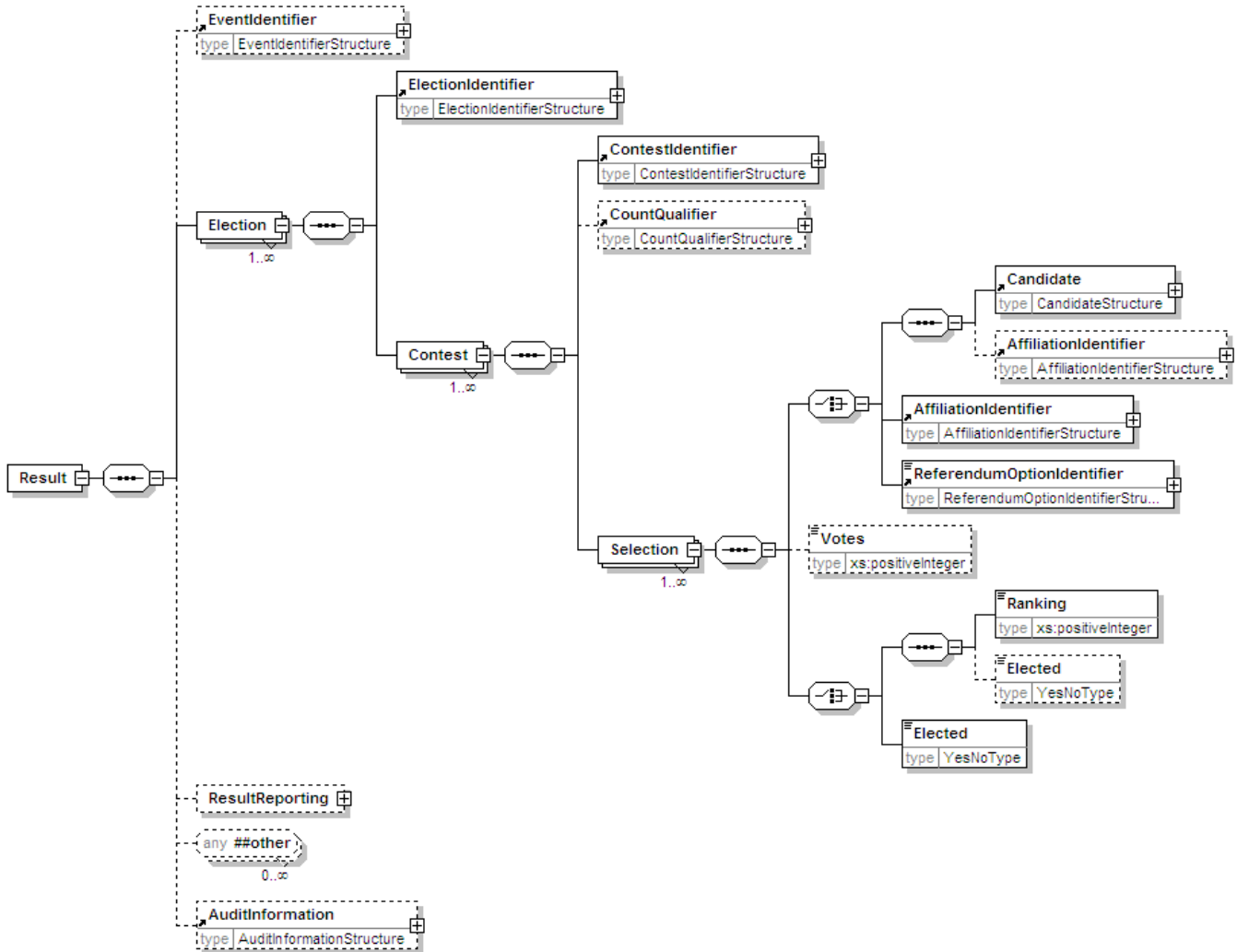

Generated by XmlSpy

www.altova.com

7.3.3 Example XML

A portion of the EML Results message for the 2007 Federal Election is shown below.

```
<?xml version="1.0" encoding="utf-8"?>
<EML xmlns="urn:oasis:names:tc:evs:schema:eml"
xmlns:ds="http://www.w3.org/2000/09/xmldsig#"
xmlns:xal="urn:oasis:names:tc:ciq:xsd:schema:xAL:2.0"
xmlns:xnl="urn:oasis:names:tc:ciq:xsd:schema:xNL:2.0"
xmlns:ts="urn:oasis:names:tc:evs:schema:eml:ts"
xmlns:xs="http://www.w3.org/2001/XMLSchema-instance"
xs:schemaLocation="urn:oasis:names:tc:evs:schema:eml ../Schema/EML/520-result-v5-
0.xsd" SchemaVersion="5" Id="cd2a4faa-efa5-45d7-b9a4-970e557fa680">
  <TransactionId>7dc03687-2b41-47f5-b4a6-b0bf4ca60bcf</TransactionId>
  <Result>
    <EventIdentifier Id="13745">
      <EventName>2007 Federal Election</EventName>
    </EventIdentifier>
    <Election>
      <ElectionIdentifier Id="H">
```

```

    <ElectionName>House of Representatives Election</ElectionName>
    <ElectionCategory>House</ElectionCategory>
  </ElectionIdentifier>
  <Contest>
    <ContestIdentifier Id="179" ShortCode="ADEL">
      <ContestName>Adelaide</ContestName>
    </ContestIdentifier>
    <Selection>
      <Candidate>
        <CandidateIdentifier Id="18003">
          <CandidateName>SOLLY, Peter</CandidateName>
        </CandidateIdentifier>
      </Candidate>
      <AffiliationIdentifier Id="37" ShortCode="GRN">
        <RegisteredName>The Greens</RegisteredName>
      </AffiliationIdentifier>
      <Elected>no</Elected>
    </Selection>
    <Selection>
      <Candidate>
        <CandidateIdentifier Id="17694">
          <CandidateName>ELLIS, Kate</CandidateName>
        </CandidateIdentifier>
      </Candidate>
      <AffiliationIdentifier Id="198" ShortCode="ALP">
        <RegisteredName>Australian Labor Party</RegisteredName>
      </AffiliationIdentifier>
      <Elected>no</Elected>
    </Selection>
    <Selection>
      <Candidate>
        <CandidateIdentifier Id="18009">
          <CandidateName>BIAR, Sandy</CandidateName>
        </CandidateIdentifier>
      </Candidate>
      <AffiliationIdentifier Id="3" ShortCode="DEM">
        <RegisteredName>Australian Democrats</RegisteredName>
      </AffiliationIdentifier>
      <Elected>no</Elected>
    </Selection>
    <Selection>
      <Candidate>
        <CandidateIdentifier Id="17610">
          <CandidateName>SLAPE, Dennis</CandidateName>
        </CandidateIdentifier>
      </Candidate>
      <AffiliationIdentifier Id="1129" ShortCode="FFP">
        <RegisteredName>Family First Party</RegisteredName>
      </AffiliationIdentifier>
      <Elected>no</Elected>
    </Selection>
    <Selection>
      <Candidate>
        <CandidateIdentifier Id="17633">
          <CandidateName>MARSH, Tracy</CandidateName>
        </CandidateIdentifier>
      </Candidate>
      <AffiliationIdentifier Id="184" ShortCode="LP">
        <RegisteredName>Liberal</RegisteredName>
      </AffiliationIdentifier>
      <Elected>no</Elected>
    </Selection>
  </Contest>

```

7.3.4 Estimated Message Size

Electoral Event	XML File Size
General Election	370 KB
General Election including Referendum	400 KB
House of Representatives By-election	7 KB
Referendum	3 KB

8. What's new in Version 3.0?

8.1 Introduction

The AEC released Version 3.0 of the Media Feed system prior to the 2010 Federal Election to support a legislation change that allowed a pre-poll vote cast within the elector's own division to be treated as an ordinary vote and counted on Election night. In general the changes contained in Version 3.0 were minor and the message XML schema remained largely unchanged compared to that used during the 2007 Federal Election. In many cases, consumers of the Media Feed did not even need to change their parsing and/or transformation software to use Version 3.0 during the 2010 Federal Election.

8.2 Election Mark-up Language (EML) Version 5.0

The media feed messages are now based on the most recent publication of the Election Mark-up Language (EML) international standard, EML version 5.0.

8.3 XML Schema Files

The media feed messages are now based on a new set of XML schema files, which are listed below:

- aec-mediafeed-ballotpapers-v3-0.xsd
- aec-mediafeed-core-v3-0.xsd
- aec-mediafeed-groupvotingtickets-v3-0.xsd
- aec-mediafeed-pollingdistricts-v3-0.xsd
- aec-mediafeed-results-v3-0.xsd

8.4 Polling place classification for pre-poll voting centres

A new polling place classification has been added to the core schema to support a possible legislation change that would allow a pre-poll vote cast within the elector's own division to be treated as an ordinary vote and counted on Election night. A new classification called "PrePollVotingCentre" has been added to the simple type "PollingPlaceClassificationType".

8.4.1 Message Schema Changes

```
<xs:simpleType name="PollingPlaceClassificationType">
  <xs:annotation>
    <xs:documentation>Simple type to indicate the type of polling
place</xs:documentation>
  </xs:annotation>
  <xs:restriction base="xs:token">
    <xs:enumeration value="Static"/>
  </xs:restriction>
</xs:simpleType>
```

```

    <xs:enumeration value="RemoteMobile"/>
    <xs:enumeration value="SpecialHospital"/>
    <xs:enumeration value="PrisonMobile"/>
    <xs:enumeration value="PrePollVotingCentre"/>
  </xs:restriction>
</xs:simpleType>

```

8.4.2 Example XML

```

<PollingPlace Updated="2010-04-27T09:46:53">
  <PollingPlaceIdentifier Id="30092" Name="Divisional Office (PREPOLL)"
    Classification="PrePollVotingCentre" />
  <FirstPreferences Updated="2010-04-27T09:46:53">
    <Candidate>
      <eml:CandidateIdentifier Id="20717" />
      <Votes Historic="0" Percentage="0" Swing="0">0</Votes>
    </Candidate>
  </FirstPreferences>
</PollingPlace>

```

8.5 Media Feed Element (File Header)

All messages that are based on the AEC schemas have the same file header. This header contains a unique ID for the message, the date and time it was created, the language used in the message, details of the organisation and system that created it and also information that links it to other messages created during the same processing cycle. Two new attributes have been added, these are:

- SchemaVersion: Indicates the version number of the AEC Media Feed schema used to generate message.
- EmlVersion: Indicates the version of the Election Mark-up Language (EML) standard referenced by the message.

A new optional element called "Platform" element has been added to the "GeneratorStructure" complex type. The "Platform" element optionally indicates if 32-bit or 64-bit computer hardware was used to generate the message.

8.5.1 Message Schema Changes

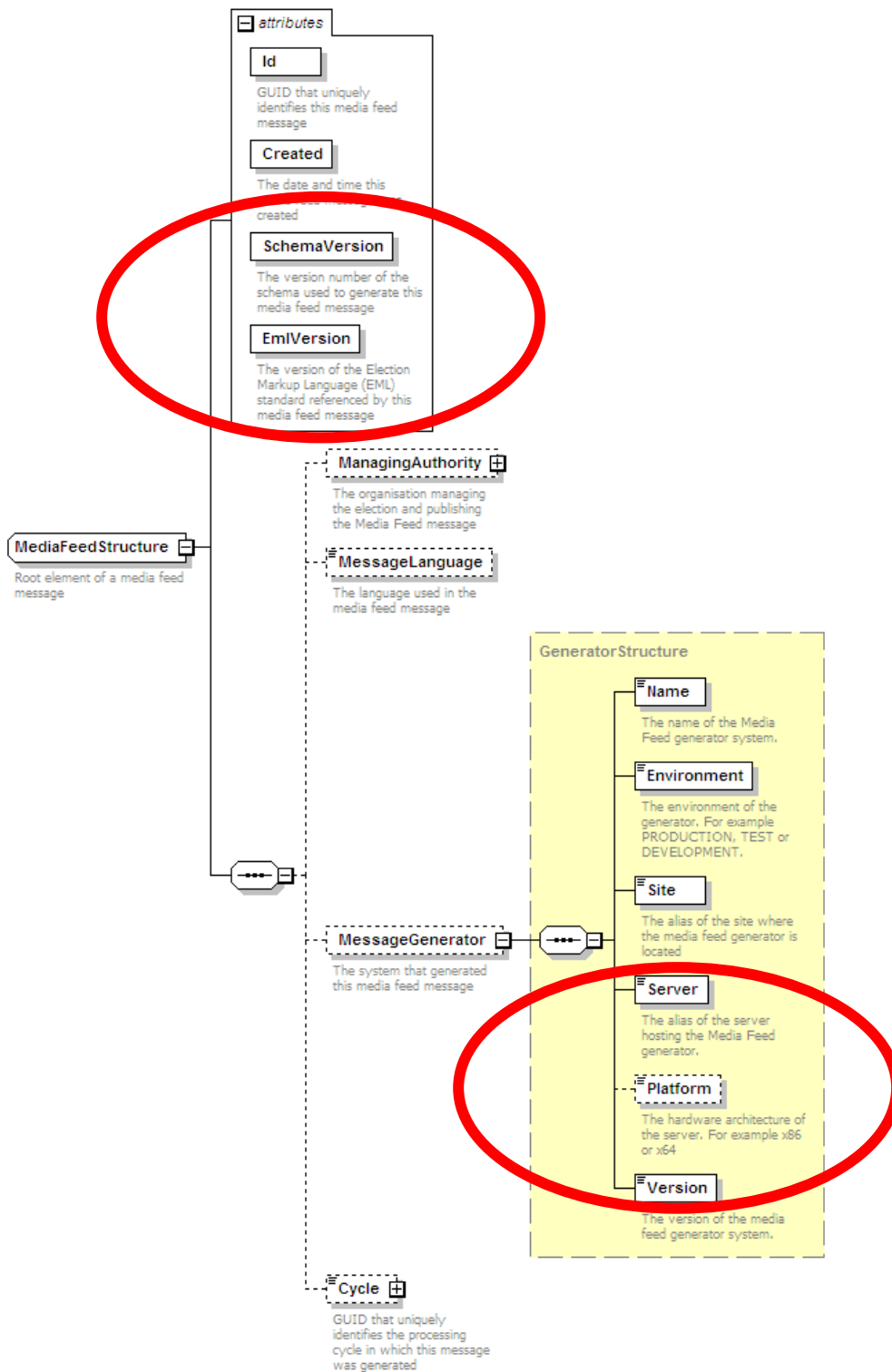

Generated by XMLSpy

www.altova.com

8.5.2 Example XML

```
<?xml version="1.0" encoding="utf-8"?>
<MediaFeed Id="ba39f8b0-98eb-405b-825c-337cf110ca5c" Created="2010-05-30T12:56:00"
SchemaVersion="3" EmlVersion="5" xmlns="http://www.aec.gov.au/xml/schema/mediafeed"
xmlns:eml="http://www.aec.gov.au/xml/schema/eml"
xmlns:names="http://www.aec.gov.au/xml/schema/names"
xmlns:tc="http://www.aec.gov.au/xml/schema/tc"
xmlns:evs="http://www.aec.gov.au/xml/schema/evs"
xmlns:evs-schema="http://www.aec.gov.au/xml/schema/evs-schema"
xmlns:evs-schema-eml="http://www.aec.gov.au/xml/schema/evs-schema-eml">
```

```

xmlns:ds="http://www.w3.org/2000/09/xmldsig#"
xmlns:xal="urn:oasis:names:tc:ciq:xsd:schema:xAL:2.0"
xmlns:xnl="urn:oasis:names:tc:ciq:xsd:schema:xNL:2.0"
xmlns:ts="urn:oasis:names:tc:evs:schema:eml:ts"
xmlns:xs="http://www.w3.org/2001/XMLSchema-instance"
xs:schemaLocation="http://www.aec.gov.au/xml/schema/mediafeed ../Schema/AEC/aec-
mediafeed-results-v3-0.xsd"
<ManagingAuthority>
  <eml:AuthorityIdentifier Id="AEC">Australian Electoral
Commission</eml:AuthorityIdentifier>
</ManagingAuthority>
<MessageLanguage>en</MessageLanguage>
<MessageGenerator>
  <Name>Virtual Tally Room</Name>
  <Environment>DEV</Environment>
  <Site>VTR</Site>
  <Server>DEV01</Server>
  <Platform>x64</Platform>
  <Version>6.0.6.5754</Version>
</MessageGenerator>
<Cycle Created="2007-11-24T20:00:24">7dc03687-2b41-47f5-b4a6-b0bf4ca60bcf</Cycle>

```

8.6 Count Message (EML message 510)

The schema of the EML 510 Count Message changed between EML version 4 and 5. The most notable change is the “Selection” element now requires a complete “Candidate” element, when previously only the “CandidateIdentifier” element was required.

8.6.1 Message Schema Changes

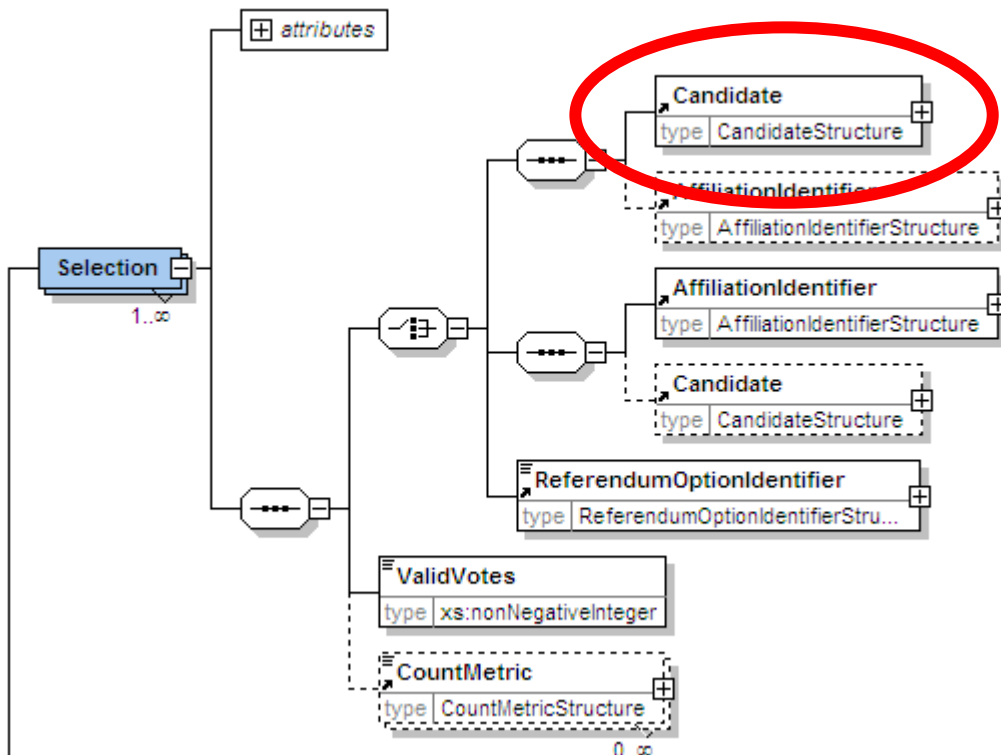

8.6.2 Example XML

A portion of the EML Count message for the 2007 Federal Election is shown below.

```

?xml version="1.0" encoding="utf-8"?>
<EML xmlns="urn:oasis:names:tc:evs:schema:eml"
xmlns:ds="http://www.w3.org/2000/09/xmldsig#"
xmlns:xal="urn:oasis:names:tc:ciq:xsdschema:xAL:2.0"
xmlns:xnl="urn:oasis:names:tc:ciq:xsdschema:xNL:2.0"
xmlns:ts="urn:oasis:names:tc:evs:schema:eml:ts"
xmlns:xs="http://www.w3.org/2001/XMLSchema-instance"
xs:schemaLocation="urn:oasis:names:tc:evs:schema:eml ../Schema/EML/510-count-v5-
0.xsd" SchemaVersion="5" Id="5a95a7c3-a870-41da-9a89-cc7c4c45c9ea">
  <TransactionId>7dc03687-2b41-47f5-b4a6-b0bf4ca60bcf</TransactionId>
  <Count>
    <EventIdentifier Id="13745">
      <EventName>2007 Federal Election</EventName>
    </EventIdentifier>
    <Election>
      <ElectionIdentifier Id="H">
        <ElectionName>House of Representatives Election</ElectionName>
        <ElectionCategory>House</ElectionCategory>
      </ElectionIdentifier>
      <Contests>
        <Contest>
          <ContestIdentifier Id="101" ShortCode="CANB">
            <ContestName>Canberra</ContestName>
          </ContestIdentifier>
          <NumberOfPositions>1</NumberOfPositions>
          <TotalVotes>
            <Selection>
              <Candidate>
                <CandidateIdentifier Id="17277">
                  <CandidateName>BRESNAN, Amanda</CandidateName>
                </CandidateIdentifier>
              </Candidate>
              <AffiliationIdentifier Id="37" ShortCode="GRN">
                <RegisteredName>The Greens</RegisteredName>
              </AffiliationIdentifier>
              <ValidVotes>4910</ValidVotes>
            </Selection>
          </TotalVotes>
        </Contest>
      </Contests>
    </Election>
  </Count>

```

8.7 Result Message (EML message 520)

The schema of the EML 520 Results Message changed between EML version 4 and 5.

The most notable change is the “Selection” element now requires a complete “Candidate” element, when previously only the “CandidateIdentifier” element was required.

8.7.1 Message Schema Changes

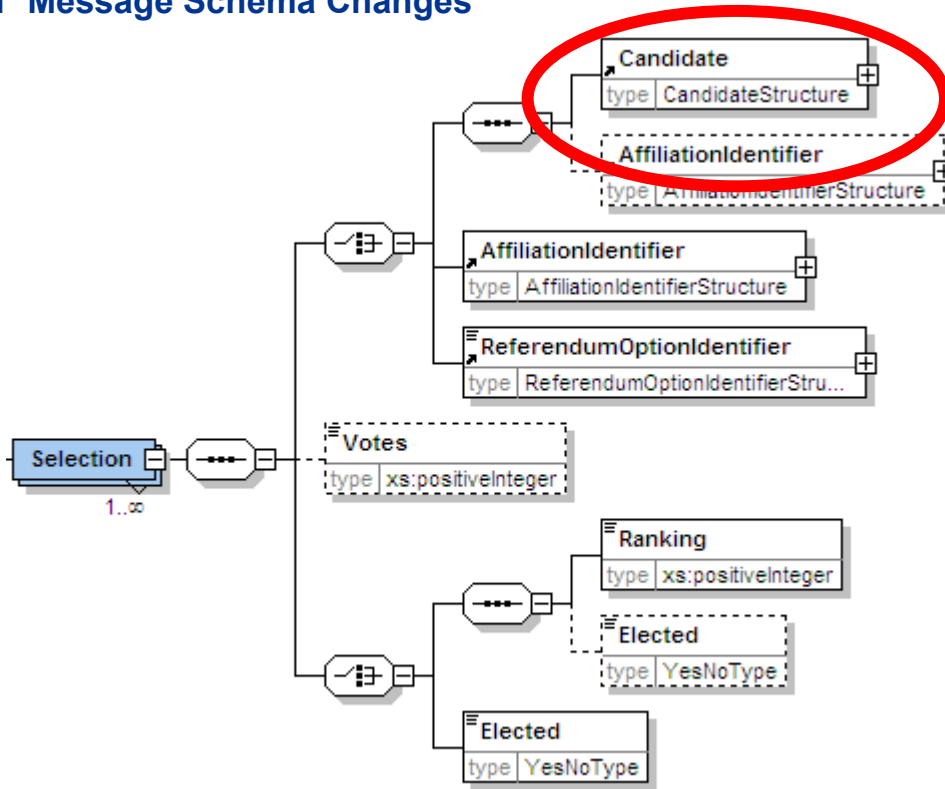

8.7.2 Example XML

A portion of the EML Results message for the 2007 Federal Election is shown below.

```
<?xml version="1.0" encoding="utf-8"?>
<EML xmlns="urn:oasis:names:tc:evs:schema:eml"
xmlns:ds="http://www.w3.org/2000/09/xmldsig#"
xmlns:xal="urn:oasis:names:tc:ciq:xsdschema:xAL:2.0"
xmlns:xnl="urn:oasis:names:tc:ciq:xsdschema:xNL:2.0"
xmlns:ts="urn:oasis:names:tc:evs:schema:eml:ts"
xmlns:xs="http://www.w3.org/2001/XMLSchema-instance"
xs:schemaLocation="urn:oasis:names:tc:evs:schema:eml ../Schema/EML/520-result-v5-
0.xsd" SchemaVersion="5" Id="cd2a4faa-efa5-45d7-b9a4-970e557fa680">
  <TransactionId>7dc03687-2b41-47f5-b4a6-b0bf4ca60bcf</TransactionId>
  <Result>
    <EventIdentifier Id="13745">
      <EventName>2007 Federal Election</EventName>
    </EventIdentifier>
    <Election>
      <ElectionIdentifier Id="H">
        <ElectionName>House of Representatives Election</ElectionName>
        <ElectionCategory>House</ElectionCategory>
      </ElectionIdentifier>
      <Contest>
        <ContestIdentifier Id="179" ShortCode="ADEL">
          <ContestName>Adelaide</ContestName>
          <ContestCategory>Contest</ContestCategory>
          <Selection>
            <Candidate>
              <CandidateIdentifier Id="18003">
                <CandidateName>SOLLY, Peter</CandidateName>
              </CandidateIdentifier>
            </Candidate>
            <AffiliationIdentifier Id="37" ShortCode="GRN">
              <RegisteredName>The Greens</RegisteredName>
            </AffiliationIdentifier>
          </Selection>
        </ContestIdentifier>
      </Contest>
    </Election>
  </Result>
</EML>
```

```
</AffiliationIdentifier>  
<Elected>no</Elected>  
</Selection>  
<Selection>
```

8.8 Cycle Times.

The AEC Media Feed will be published every 90 seconds on election night and every 15 minutes in the post-election period.

9. Frequently Asked Questions

9.1 Do all AEC messages have the same header?

Yes, all messages that are based on AEC schemas have the same file header. This header contains a unique ID for the message, the date and time it was created, the language used in the message, details of the organisation and system that created it and also information that links it to other messages created during the same processing cycle.

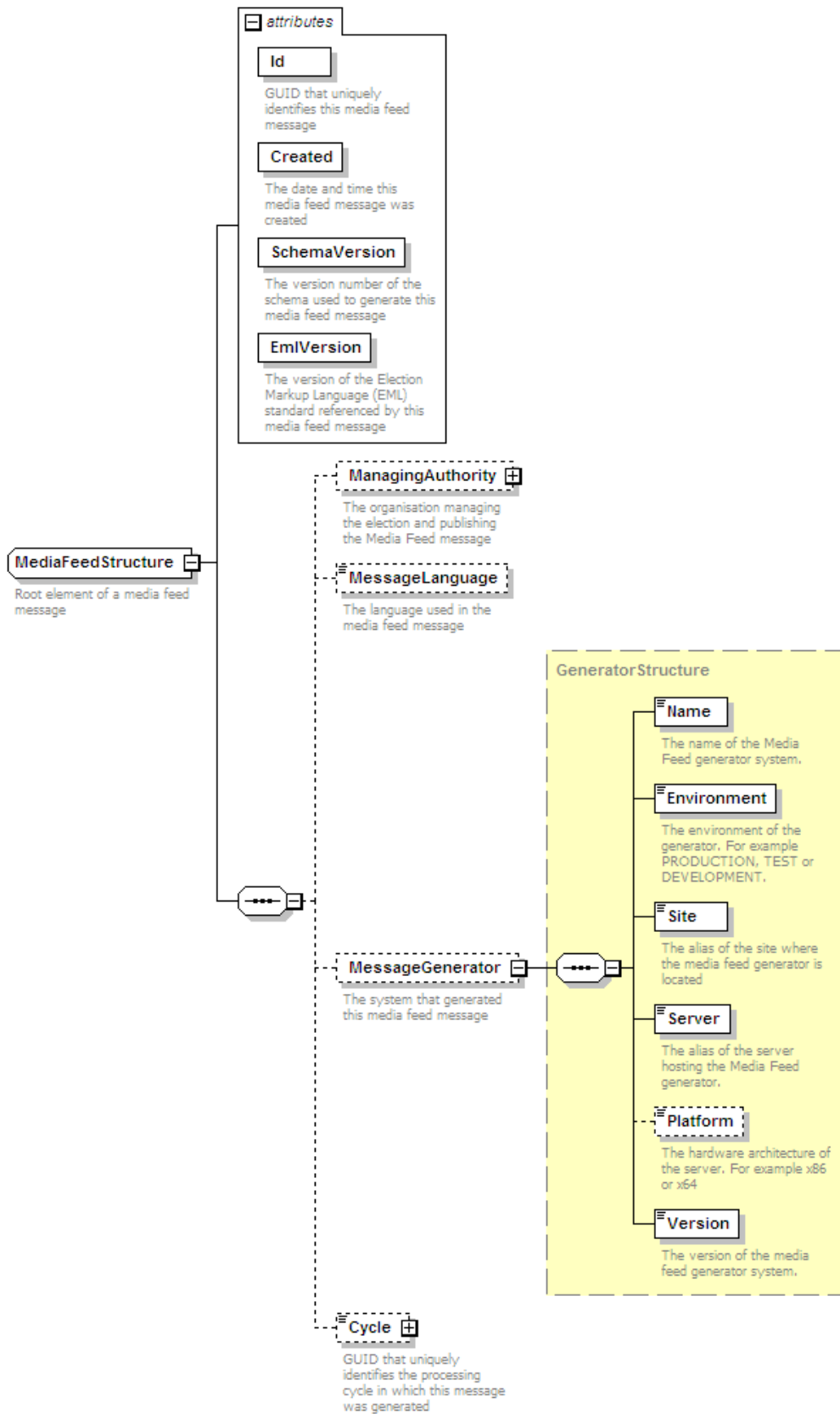

```

<?xml version="1.0" encoding="utf-8"?>
<MediaFeed Id="ba3928b0-98eb-405b-825c-337cf110ca5c" Created="2010-05-30T12:56:00"
SchemaVersion="3" EmlVersion="5" xmlns="http://www.aec.gov.au/xml/schema/mediafeed"
xmlns:eml="urn:oasis:names:tc:evs:schema:eml"
xmlns:ds="http://www.w3.org/2000/09/xmldsig#"
xmlns:xal="urn:oasis:names:tc:ciq:xsd:schema:xAL:2.0"
xmlns:xnl="urn:oasis:names:tc:ciq:xsd:schema:xNL:2.0"
xmlns:ts="urn:oasis:names:tc:evs:schema:eml:ts"
xmlns:xs="http://www.w3.org/2001/XMLSchema-instance"
xs:schemaLocation="http://www.aec.gov.au/xml/schema/mediafeed ../Schema/AEC/aec-
mediafeed-results-v3-0.xsd">
  <ManagingAuthority>
    <eml:AuthorityIdentifier Id="AEC">Australian Electoral
Commission</eml:AuthorityIdentifier>
  </ManagingAuthority>
  <MessageLanguage>en</MessageLanguage>
  <MessageGenerator>
    <Name>Virtual Tally Room</Name>
    <Environment>DEV</Environment>
    <Site>PARKES</Site>
    <Server>DEV01</Server>
    <Platform>x64</Platform>
    <Version>6.0.6.5754</Version>
  </MessageGenerator>
  <Cycle Created="2007-11-24T20:00:24">7dc03687-2b41-47f5-b4a6-b0bf4ca60bcf</Cycle>

```

9.2 How can I determine if the message was generated on Election Night?

The Results element of the Results message contains the Phase attribute. This indicates the phase in the election period when the message was generated. The Phase attribute can have one of the following values: *IssueOfWrit*; *CloseOfRolls*; *NominationsLocked*; *Preload*; *PreloadLocked*; *ElectionNight*; *PostElection*; or *FinalResults*.

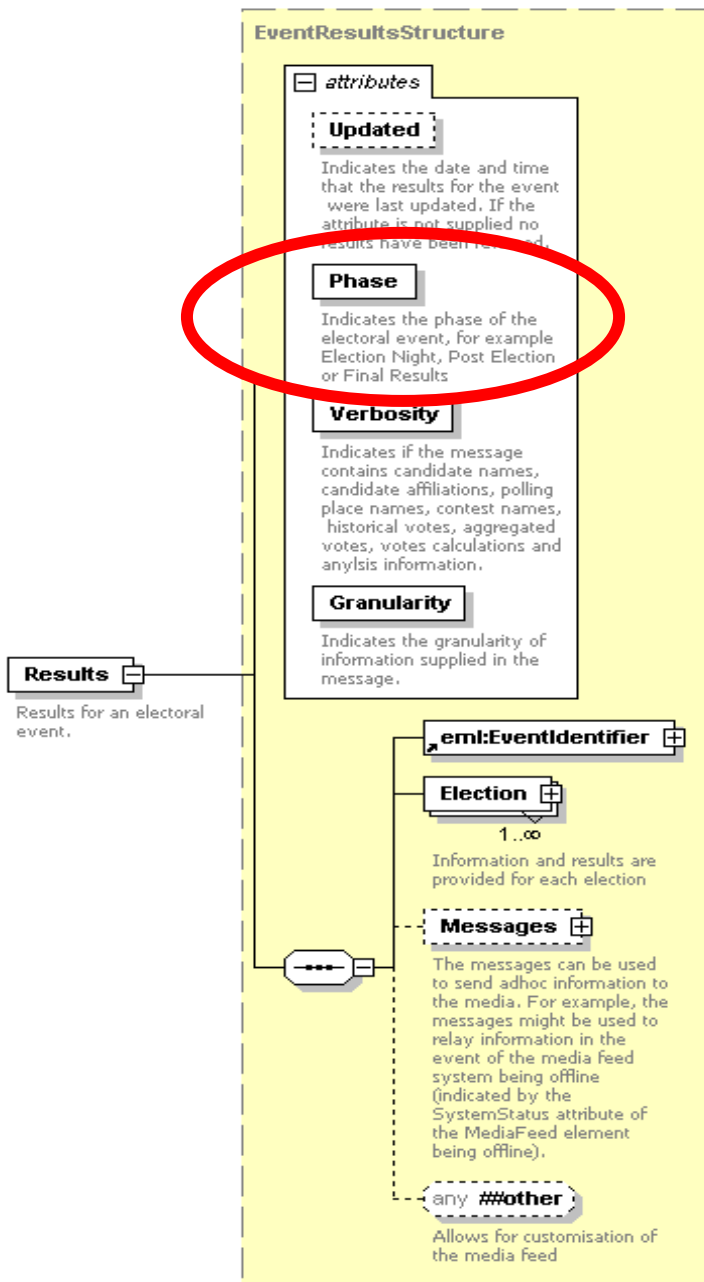

Generated by XmlSpy

www.altova.com

```
<Cycle Created="2006-11-20T10:59:42">e28bc89e-180d-4520-9fcb-8c718d3d0864</Cycle>
<Results Updated="2004-12-10T11:35:46" Phase="ElectionNight" Verbosity="Verbose"
Granularity="Standard">
  <eml:EventIdentifier Id="12246">
    <eml:EventName>2004 Federal Election</eml:EventName>
  </eml:EventIdentifier>
  <Election Updated="2004-11-26T14:36:56">
    <eml:ElectionIdentifier Id="H">
      <eml:ElectionName>House of Representatives Election</eml:ElectionName>
      <eml:ElectionCategory>House</eml:ElectionCategory>
    </eml:ElectionIdentifier>
```

9.3 How can I determine if any results have changed since the last feed?

The Results element of the Results message contains the **Updated** attribute. This indicates the most recent date and time that any results for the electoral event were updated.

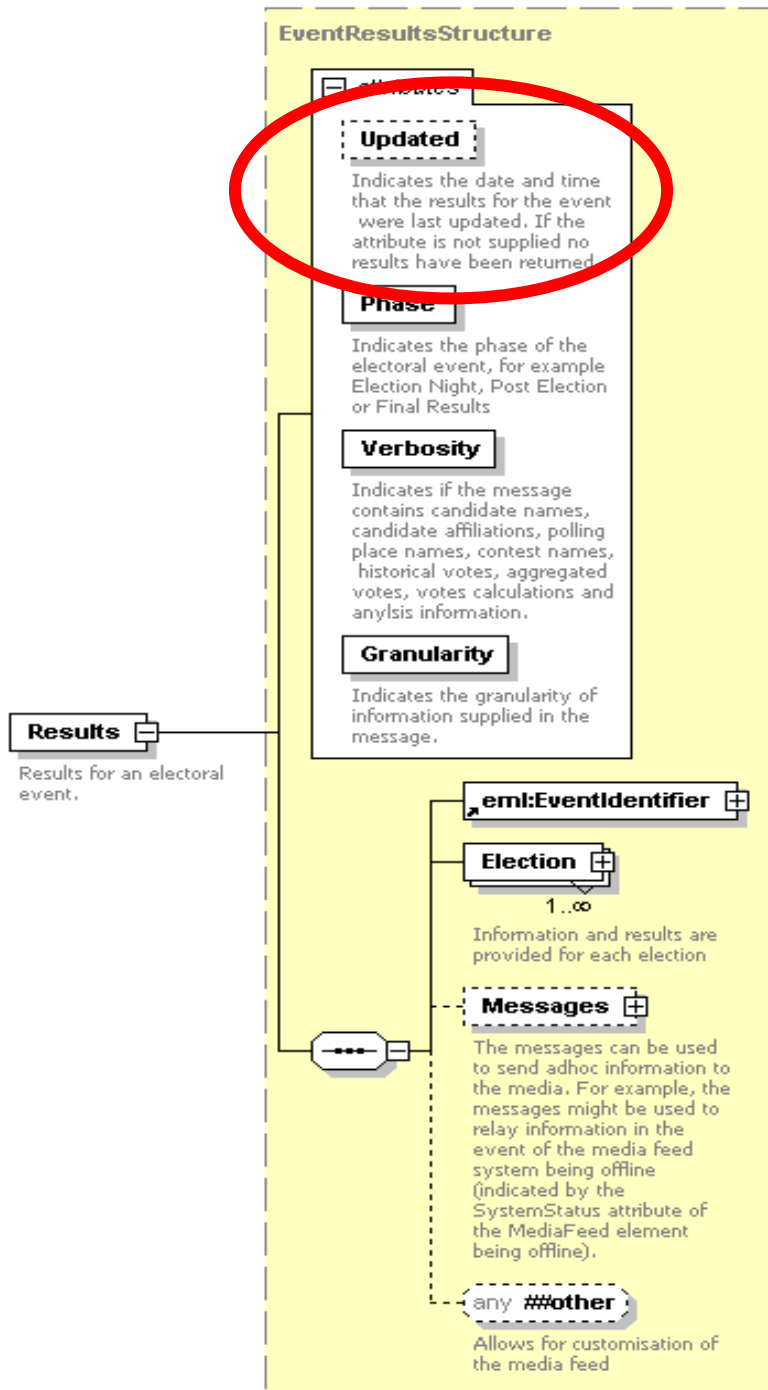

Generated by XmlSpy

www.altova.com

```

<Cycle Created="2006-11-20T10:50:42">e20bc89e-180d-4520-9fcb-8c728d3d0864</Cycle>
<Results Updated="2004-12-10T15:35:46" Phase="ElectionNight" Verbosity="Verbose"
Granularity="Standard">
  <eml:EventIdentifier Id="12246">
    <eml:EventName>2004 Federal Election</eml:EventName>
  </eml:EventIdentifier>
  <Election Updated="2004-11-26T14:36:56">
    <eml:ElectionIdentifier Id="H">
      <eml:ElectionName>House of Representatives Election</eml:ElectionName>
      <eml:ElectionCategory>House</eml:ElectionCategory>
    </eml:ElectionIdentifier>
  </Election>
</Results>

```

9.4 How can I determine if there is an incorrect divisional Two Candidate Preferred selection on election night?

The **TwoCandidatePreferred** element of the MediaFeed message contains the **'Maverick'** attribute. This indicates if the incorrect TCP candidates were selected by the AEC for the initial TCP count.

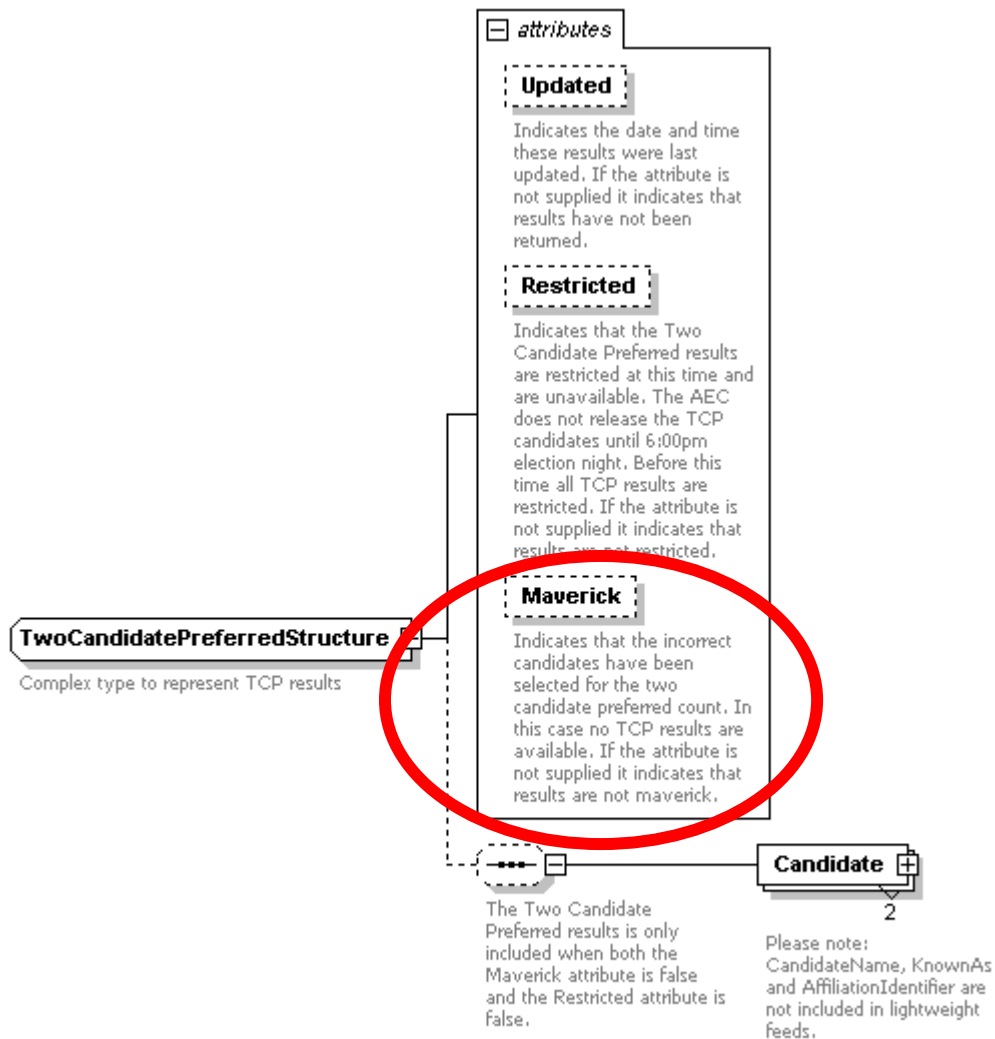

```
<TwoCandidatePreferred Updated="2004-10-28T15:17:09" Maverick="true"  
PollingPlacesReturned="47" PollingPlacesExpected="47" />
```

9.5 Why am I unable to see TCP results for a division(s)?

The AEC does not display TCP results for a division under two circumstances.

1. The incorrect TCP candidates were selected by the AEC for the initial TCP count. In this case the 'Maverick' attribute of the TwoCandidatePreferred element is set to the value of true.
2. The AEC does not release the TCP candidate selections until 6:00pm on election night. Before this time the Restricted attribute of the TwoCandidatePreferred element is set to the value of true.

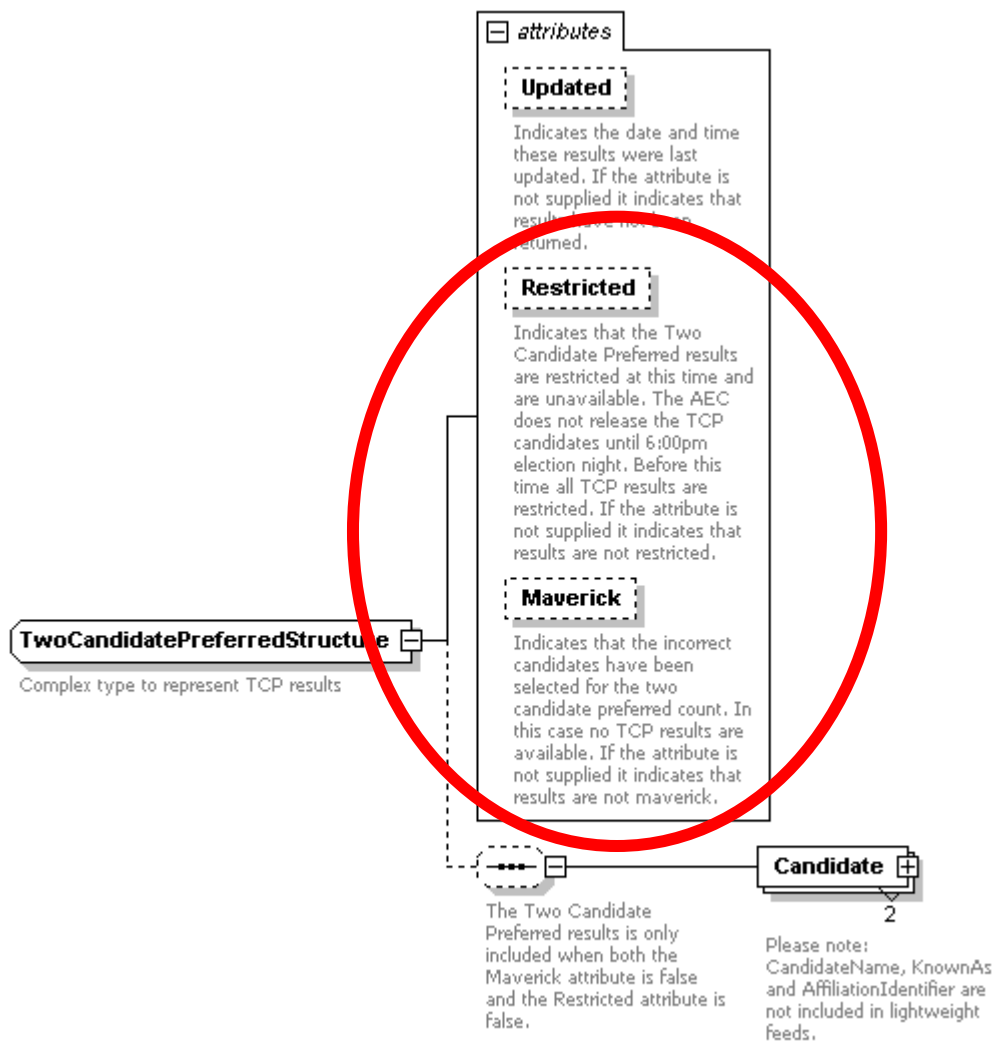

Generated by XmlSpy

www.altova.com

```
<TwoCandidatePreferred Updated="2004-10-28T15:17:09" Maverick="true"
PollingPlacesReturned="47" PollingPlacesExpected="47" />
```

```
<TwoCandidatePreferred Updated="2004-10-28T15:17:09" Restricted="true"
PollingPlacesReturned="47" PollingPlacesExpected="47" />
```

9.6 What are the main differences between the light and verbose messages?

9.6.1 Candidates elements

Candidate name and Party details are not included in the Light message.

9.6.1.1 Verbose

```
<Candidate>
  <eml:CandidateIdentifier Id="15421">
    <eml:CandidateName>ELLERMAN, Sue</eml:CandidateName>
  </eml:CandidateIdentifier>
  <eml:AffiliationIdentifier Id="37" ShortCode="GRN">
    <eml:RegisteredName>The Greens</eml:RegisteredName>
  </eml:AffiliationIdentifier>
  <BallotPosition>1</BallotPosition>
  <Elected Historic="false">>false</Elected>
  <Incumbent Notional="false">>false</Incumbent>
  <Votes Historic="0" Percentage="10.17" Swing="3.92"
  MatchedHistoric="6268">10243</Votes>
  <VotesByType>
    <Votes Type="Ordinary" Historic="0" Percentage="9.82" Swing="3.66">7687</Votes>
    <Votes Type="Absent" Historic="0" Percentage="16.24" Swing="5.21">336</Votes>
    <Votes Type="Provisional" Historic="0" Percentage="13.99" Swing="8.1">141</Votes>
    <Votes Type="PrePoll" Historic="0" Percentage="10.88" Swing="4.78">1713</Votes>
    <Votes Type="Postal" Historic="0" Percentage="10.19" Swing="5.3">366</Votes>
  </VotesByType>
</Candidate>
```

9.6.1.2 Light

```
<Candidate>
  <eml:CandidateIdentifier Id="14756" />
  <BallotPosition>1</BallotPosition>
  <Elected>>false</Elected>
  <Votes MatchedHistoric="0">2067</Votes>
  <VotesByType>
    <Votes Type="Ordinary">1719</Votes>
    <Votes Type="Absent">35</Votes>
    <Votes Type="Provisional">57</Votes>
    <Votes Type="PrePoll">218</Votes>
    <Votes Type="Postal">38</Votes>
  </VotesByType>
</Candidate>
```

9.6.2 Vote elements

Historic votes, percentage, swings and other historic or calculated information is not included in the Light message.

9.6.2.1 Verbose

```
<Votes Historic="0" Percentage="10.17" Swing="3.92"
  MatchedHistoric="6268">10243</Votes>
<VotesByType>
  <Votes Type="Ordinary" Historic="0" Percentage="9.82" Swing="3.66">7687</Votes>
  <Votes Type="Absent" Historic="0" Percentage="16.24" Swing="5.21">336</Votes>
  <Votes Type="Provisional" Historic="0" Percentage="13.99" Swing="8.1">141</Votes>
  <Votes Type="PrePoll" Historic="0" Percentage="10.88" Swing="4.78">1713</Votes>
  <Votes Type="Postal" Historic="0" Percentage="10.19" Swing="5.3">366</Votes>
</VotesByType>
```

9.6.2.2 Light

```
<Votes MatchedHistoric="0">2067</Votes>
```

```

<VotesByType>
  <Votes Type="Ordinary">1719</Votes>
  <Votes Type="Absent">35</Votes>
  <Votes Type="Provisional">57</Votes>
  <Votes Type="PrePoll">218</Votes>
  <Votes Type="Postal">38</Votes>
</VotesByType>
    
```

9.7 How can I determine if a Division has been declared?

The *Declared* attribute of the *Contest* element indicates the date and time a winner was declared for the contest. If the attribute is not supplied no winner has been declared.

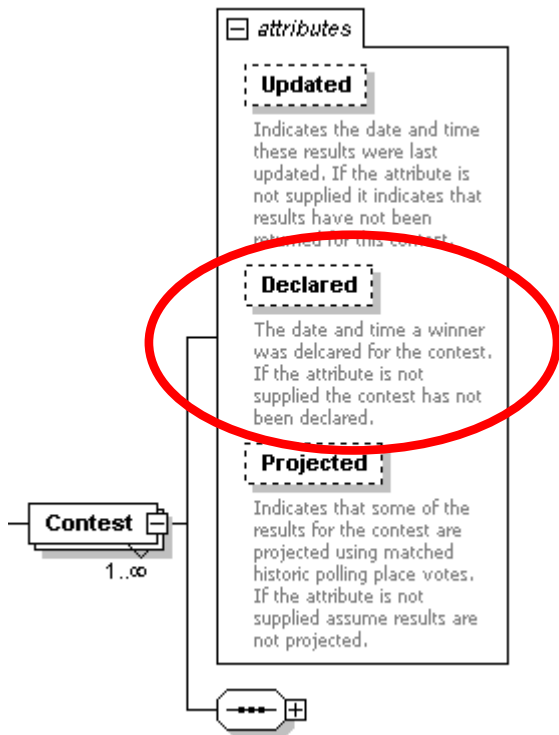

9.7.1 Declared Contest Sample

```

<Election Updated="2004-11-26T14:36:56">
  <eml:ElectionIdentifier Id="H">
    <eml:ElectionName>House of Representatives Election</eml:ElectionName>
    <eml:ElectionCategory>House</eml:ElectionCategory>
  </eml:ElectionIdentifier>
  <House>
    <Contest>
      <Contest Updated="2004-10-26T11:01:59" Declared="2004-10-28T00:00:00">
        <eml:ContestIdentifier Id="101">
          <eml:ContestName>Canberra</eml:ContestName>
        </eml:ContestIdentifier>
      </Contest>
    </Contest>
  </House>
</Election>
    
```

9.7.2 Undeclared Contest

```
<Election Updated="2004-11-26T14:36:56">
  <eml:ElectionIdentifier Id="H">
    <eml:ElectionName>House of Representatives Election</eml:ElectionName>
    <eml:ElectionCategory>House</eml:ElectionCategory>
  </eml:ElectionIdentifier>
  <House>
    <Contests>
      <Contest Updated="2004-10-26T11:01:59">
        <eml:ContestIdentifier Id="101">
          <eml:ContestName>Canberra</eml:ContestName>
        </eml:ContestIdentifier>
      </Contest>
    </Contests>
  </House>
</Election>
```

9.8 How can I determine the progress of the count?

A number of elements in the schema contain *Updated* attributes that indicate the date and time the results were last updated. If the *Updated* attribute is missing it indicates that the result have not yet been updated. The *PollingPlacesReturned* and *PollingPlacesExpected* attributes indicate the number of polling places that have returned for a particular count.

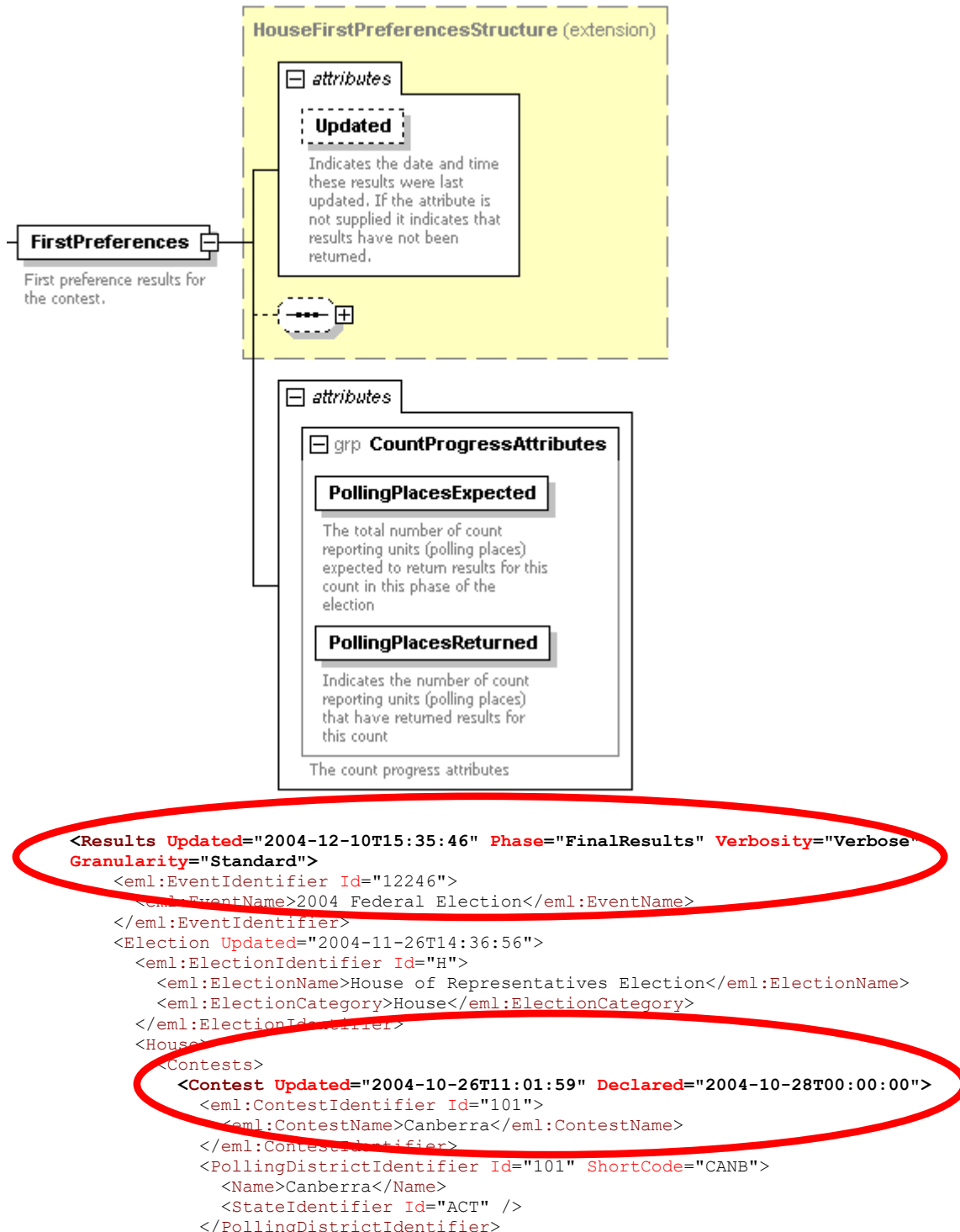

```
<Enrolment CloseOfRolls="108369" Historic="108959">109476</Enrolment>  
<FirstPreferences Updated="2004-10-26T11:25:05"  
PollingPlacesReturned="39" PollingPlacesExpected="39">  
<Candidate>  
  <eml:CandidateIdentifier Id="15421">  
    <eml:CandidateName>ELLERMAN, Sue</eml:CandidateName>  
  </eml:CandidateIdentifier>
```

9.9 How can I determine if the results are finalised?

The Results element of the Results message contains the **Phase** attribute. This indicates the phase in the election period when the message was generated. When the **Phase** attribute has the value *FinalResults* the election results will no longer change.

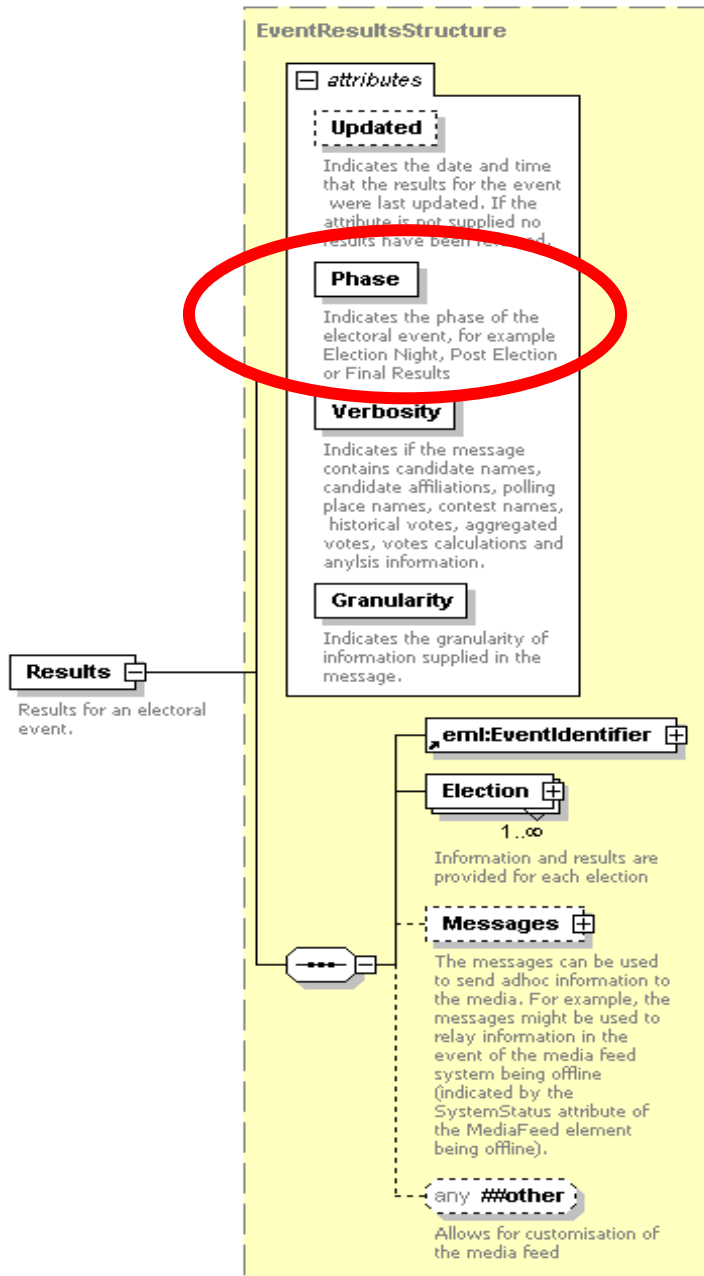

Generated by XmlSpy

www.altova.com

```
<Cycle Created="2006-11-20T10:50:47" Id="e28bc89e-180d-4520-9fcb-8c728d0d0864" />
<Results Updated="2004-12-10T15:35:46" Phase="FinalResults" Verbosity="Verbose"
Granularity="Standard">
  <eml:EventIdentifier Id="12246">
    <eml:EventName>2004 Federal Election</eml:EventName>
  </eml:EventIdentifier>
  <Election Updated="2004-11-26T14:36:56">
```

```

<eml:ElectionIdentifier Id="H">
  <eml:ElectionName>House of Representatives Election</eml:ElectionName>
  <eml:ElectionCategory>House</eml:ElectionCategory>
</eml:ElectionIdentifier>

```

9.10 When are Matched Historic votes available?

Matched historic votes represent the sum of historic ordinary votes for those polling places that returned at this election. Matched historic votes are used to project swings early on election night, which prevents large variations in swing as different sized or demographic polling places return.

The *MatchedHistoric* attribute is shown in all election phases.

```

<Candidate>
  <eml:CandidateIdentifier Id="15421">
    <eml:CandidateName>ELLERMAN, Sue</eml:CandidateName>
  </eml:CandidateIdentifier>
  <eml:AffiliationIdentifier Id="37" ShortCode="GRN">
    <eml:RegisteredName>The Greens</eml:RegisteredName>
  </eml:AffiliationIdentifier>
  <BallotPosition>1</BallotPosition>
  <Elected Historic="false">>false</Elected>
  <Incumbent Notional="false">>false</Incumbent>
  <Votes Historic="0" Percentage="10.17" Swing="3.92"
  MatchedHistoric="6268">10243</Votes>
  <VotesByType>
    <Votes Type="Ordinary" Historic="0" Percentage="9.82" Swing="3.66">7687</Votes>
    <Votes Type="Absent" Historic="0" Percentage="16.24" Swing="5.21">336</Votes>
    <Votes Type="Provisional" Historic="0" Percentage="13.99" Swing="8.1">141</Votes>
    <Votes Type="PrePoll" Historic="0" Percentage="10.88" Swing="4.78">1713</Votes>
    <Votes Type="Postal" Historic="0" Percentage="10.19" Swing="5.3">366</Votes>
  </VotesByType>
</Candidate>

```

9.11 Are Polling Place Latitudes and Longitudes available?

Where available, polling place latitude and longitude are provided in the Polling District message.

The latitude and longitude have been calculated with GDA94 standard.

9.11.1 Example with Latitude and Longitude available

```

<PollingDistrict>
  <PollingDistrictIdentifier Id="103" ShortCode="BANK">
    <Name>Banks</Name>
    <StateIdentifier Id="NSW" />
  </PollingDistrictIdentifier>
  <NameDerivation>Named after botanist Sir Joseph Banks 1743-1820, who accompanied Captain Cook on his voyage to Australia in 1770.</NameDerivation>
  <ProductsIndustry>Light manufacturing, commercial and service industries.</ProductsIndustry>
  <Location>Banks covers an area of approximately 55 sq km bordered by the Georges River in the west and south, the Illawarra railway line and King Georges Road in the east and Milperra and Canterbury Roads in the north. The main suburbs include East Hills, Lugarno, Narwee, Padstow, Padstow Heights, Panania, Peakhurst, Peakhurst Heights, Picnic Point, Revesby Heights, Riverwood and portions of Bankstown, Beverly Hills, Milperra, Mortdale, Oatley, Penhurst, Punchbowl, Revesby and Roselands.</Location>
  <Demographic>InnerMetropolitan</Demographic>
  <Area>55</Area>

```

```

<PollingPlaces>
  <PollingPlace Channel="polling">
    <eml:PhysicalLocation Id="1">
      <eml:Address AddressDetailsKey="Beverly Hills North">
        <xal:PostalServiceElements Type="GDA94">
          <xal:AddressLatitude>-1.08923</xal:AddressLatitude>
          <xal:AddressLongitude>234.098567565</xal:AddressLongitude>
        </xal:PostalServiceElements>
        <xal:AddressLines>
          <xal:AddressLine Type="Premises">Beverly Hills North Public
School</xal:AddressLine>
          <xal:AddressLine Type="Municipality">Shorster Ave</xal:AddressLine>
          <xal:AddressLine Type="Suburb">BEVERLY HILLS</xal:AddressLine>
          <xal:AddressLine Type="State">NSW</xal:AddressLine>
          <xal:AddressLine Type="Postcode">2209</xal:AddressLine>
        </xal:AddressLines>
      </eml:Address>
    </eml:PhysicalLocation>
    <PollingPlaceIdentifier Id="1" Name="Beverly Hills North" />
    <WheelchairAccess>Assisted</WheelchairAccess>
  </PollingPlace>

```

9.11.2 Example with Latitude and Longitude unavailable

```

<PollingDistrict>
  <PollingDistrictIdentifier Id="103" ShortCode="BANK">
    <Name>Banks</Name>
    <StateIdentifier Id="NSW" />
  </PollingDistrictIdentifier>
  <NameDerivation>Named after botanist Sir Joseph Banks 1743-1820, who accompanied Captain
Cook on his voyage to Australia in 1770.</NameDerivation>
  <ProductsIndustry>Light manufacturing, commercial and service
industries.</ProductsIndustry>
  <Location>Banks covers an area of approximately 55 sq km bordered by the Georges River in
the west and south, the Illawarra railway line and King Georges Road in the east and
Milperra and Canterbury Roads in the north. The main suburbs include East Hills, Lugarno,
Narwee, Padstow, Padstow Heights, Panania, Peakhurst, Peakhurst Heights, Picnic Point,
Revesby Heights, Riverwood and portions of Bankstown, Beverly Hills, Milperra, Mortdale,
Oatley, Penshurst, Punchbowl, Revesby and Roselands.</Location>
  <Demographic>InnerMetropolitan</Demographic>
  <Area>55</Area>
  <PollingPlaces>
    <PollingPlace Channel="polling">
      <eml:PhysicalLocation Id="33758">
        <eml:Address AddressDetailsKey="Beverly Hills South (Banks)">
          <xal:PostalServiceElements Type="GDA94">
            <xal:AddressLatitude />
            <xal:AddressLongitude />
          </xal:PostalServiceElements>
          <xal:AddressLines>
            <xal:AddressLine Type="Premises">Beverly Hills Public School</xal:AddressLine>
            <xal:AddressLine Type="AddressLine1">Camp King Georges & Stoney Creek
Rds</xal:AddressLine>
            <xal:AddressLine Type="Suburb">BEVERLY HILLS</xal:AddressLine>
            <xal:AddressLine Type="State">NSW</xal:AddressLine>
            <xal:AddressLine Type="Postcode">2209</xal:AddressLine>
          </xal:AddressLines>
        </eml:Address>
      </eml:PhysicalLocation>
      <PollingPlaceIdentifier Id="33758" Name="Beverly Hills South (Banks)" />
      <WheelchairAccess>Assisted</WheelchairAccess>
    </PollingPlace>

```

9.12 How can I determine the TCP matched historic for Polling Places that have returned First Preferences?

The Vote structure supports TCP Matched Historic for Polling Places that have returned First Preferences.

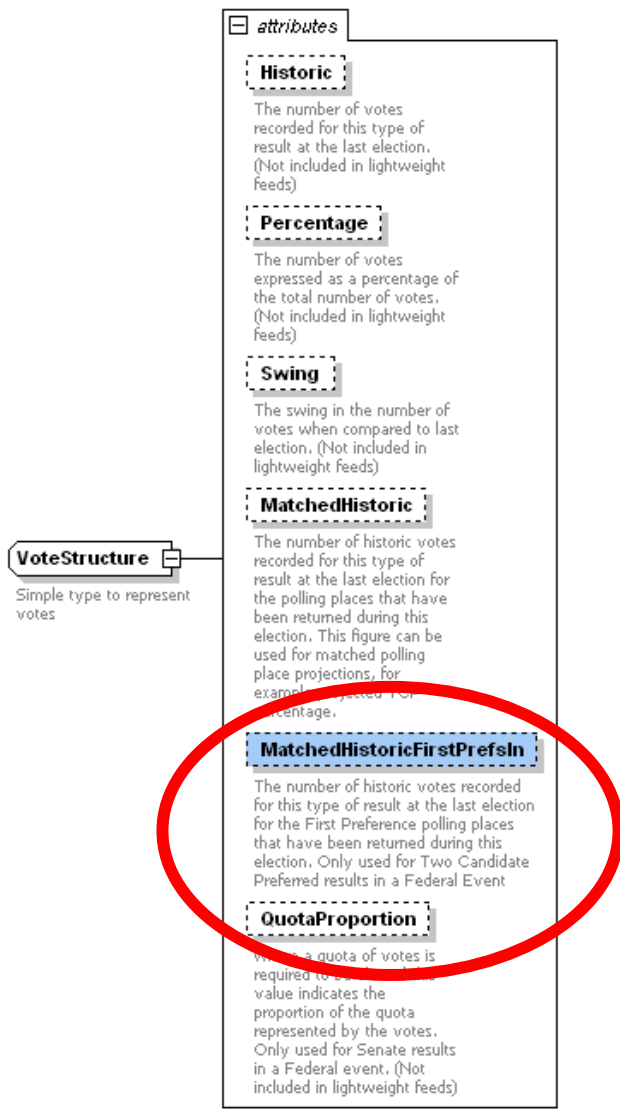

```

<TwoCandidatePreferred Updated="2004-10-26T11:01:59" PollingPlacesReturned="37"
PollingPlacesExpected="37">
  <Candidate>
    <eml:CandidateIdentifier Id="15166">
      <eml:CandidateName>BARNIER, Belinda</eml:CandidateName>
    </eml:CandidateIdentifier>
    <eml:AffiliationIdentifier Id="177" ShortCode="LP">
      <eml:RegisteredName>Liberal</eml:RegisteredName>
    </eml:AffiliationIdentifier>
    <BallotPosition>2</BallotPosition>
    <Elected Historic="false">>false</Elected>
    <Incumbent Notional="false">>false</Incumbent>
    <Votes Historic="40696" Percentage="39.93" Swing="-0.63" MatchedHistoric="40696"
MatchedHistoricFirstPrefsIn="40696">30990</Votes>
    <VotesByType>
      <Votes Type="Ordinary" Historic="32245" Percentage="40.08" Swing="-0.28">30990</Votes>
      <Votes Type="Absent" Historic="0" Percentage="39.63" Swing="39.63">0</Votes>
      <Votes Type="Provisional" Historic="0" Percentage="38.49" Swing="38.49">0</Votes>
      <Votes Type="PrePoll" Historic="0" Percentage="40.97" Swing="40.97">0</Votes>
      <Votes Type="Postal" Historic="0" Percentage="45.14" Swing="45.14">0</Votes>
    </VotesByType>
  </Candidate>
  <Candidate>
    <eml:CandidateIdentifier Id="15360">
      <eml:CandidateName>ELLIS, Annette</eml:CandidateName>
    </eml:CandidateIdentifier>
    <eml:AffiliationIdentifier Id="200" ShortCode="ALP">
      <eml:RegisteredName>Australian Labor Party (ACT Branch)</eml:RegisteredName>
    </eml:AffiliationIdentifier>
    <BallotPosition>4</BallotPosition>
    <Elected Historic="false">>true</Elected>
    <Incumbent Notional="true">>true</Incumbent>
    <Votes Historic="59632" Percentage="60.07" Swing="0.63" MatchedHistoric="59632"
    MatchedHistoricFirstPrefsIn="0">46622</Votes>
    <VotesByType>
      <Votes Type="Ordinary" Historic="47641" Percentage="59.92" Swing="0.28">46622</Votes>
      <Votes Type="Absent" Historic="0" Percentage="60.37" Swing="60.37">0</Votes>
      <Votes Type="Provisional" Historic="0" Percentage="61.51" Swing="61.51">0</Votes>
      <Votes Type="PrePoll" Historic="0" Percentage="59.03" Swing="59.03">0</Votes>
      <Votes Type="Postal" Historic="0" Percentage="54.86" Swing="54.86">0</Votes>
    </VotesByType>
  </Candidate>
</TwoCandidatePreferred>

```

9.13 How can I determine a Candidate's position on the ballot paper?

Ballot position is included for all candidates and ghosts in all results messages for First Preferences and TCP results at the Division level. Ballot position is not be provided for results at the polling place level to optimise message size.

```

<Contests>
  <Contest Updated="2004-10-26T11:01:59" Declared="2004-10-28T00:00:00">
    <eml:ContestIdentifier Id="101">
      <eml:ContestName>Canberra</eml:ContestName>
    </eml:ContestIdentifier>
    <Enrolment>109476</Enrolment>
    <FirstPreferences Updated="2004-10-26T11:25:05"
    PollingPlacesReturned="39" PollingPlacesExpected="39">
      <Candidate>
        <eml:CandidateIdentifier Id="15421" />
        <BallotPosition>1</BallotPosition>
        <Elected>>false</Elected>
        <Votes MatchedHistoric="4022" MatchedHistoricFirstPrefsIn="4022">7687</Votes>
      <VotesByType>
        <Votes Type="Ordinary">7687</Votes>
      </VotesByType>
    </Candidate>
  </FirstPreferences>
</Contest>

```

```

<Votes Type="Absent">336</Votes>
<Votes Type="Provisional">141</Votes>
<Votes Type="PrePoll">1713</Votes>
<Votes Type="Postal">366</Votes>
</VotesByType>
</Candidate>
    
```

9.14 Is there a message that contains the ballot paper definition?

Yes, there is a message in the Preload feed that contains an electronic definition of the ballot papers used during the election and is based on the XML schema aec-mediafeed-ballotpapers-v3-0.xsd. See Section 6.7 for more Information.

9.15 What is the difference between Elected Historic and Incumbent?

The definition of the Elected and Incumbent elements is shown below.

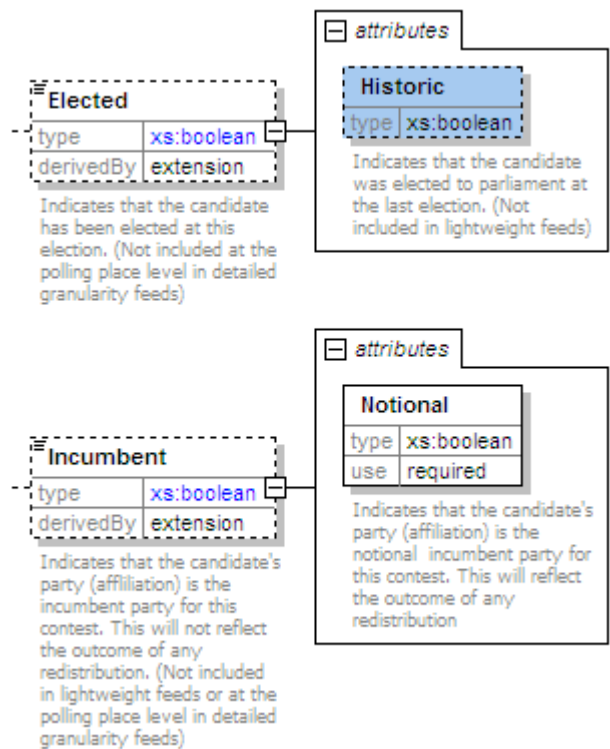

The historic attribute of the elected element indicates that the candidate is a current MP, regardless of which division they currently hold or the division they are contesting during the current election.

For example, John Cobb won the division of Parkes at the 2004 Federal Election. However, as a result of redistribution he chose to contest the division of Calare at the 2007 Federal Election. Therefore John Cobb was not the incumbent for the Division of

Calare, however since he was elected to parliament at the last election he was marked as “Elected Historic = true”.

```
<Candidate>
  <eml:CandidateIdentifier Id="17206">
    <eml:CandidateName>COBB, John</eml:CandidateName>
  </eml:CandidateIdentifier>
  <eml:AffiliationIdentifier Id="172" ShortCode="NP">
    <eml:RegisteredName>Nationals</eml:RegisteredName>
  </eml:AffiliationIdentifier>
  <BallotPosition>4</BallotPosition>
  <Elected Historic="true">>false</Elected>
</Incumbent Notional="false">>false</Incumbent>
```

The incumbent element indicates that a candidate's party (affiliation) is the incumbent party for the contest and does not reflect the outcome of any redistribution. The notional attribute indicates that the candidate's party (affiliation) is the notional incumbent party for the contest as a result of any redistribution.

For example, at the 2007 Federal Election for the division of Grey (SA) Barry Wakelin retired and was replaced by a new Liberal candidate, Rowan Ramsey. As you can see below, Rowan Ramsey was not historic elected but was the incumbent and notional incumbent.

```
<Candidate>
  <eml:CandidateIdentifier Id="17679">
    <eml:CandidateName>RAMSEY, Rowan</eml:CandidateName>
  </eml:CandidateIdentifier>
  <eml:AffiliationIdentifier Id="184" ShortCode="LP">
    <eml:RegisteredName>Liberal</eml:RegisteredName>
  </eml:AffiliationIdentifier>
  <BallotPosition>1</BallotPosition>
  <Elected Historic="false">>false</Elected>
  <Incumbent Notional="true">>true</Incumbent>
```

For example, at the 2007 Federal Election the Liberals got redistributed out of the division of Macquarie (NSW). In this case Kerry Bartlett (LP) was Historic Elected and incumbent however Bob Debus (ALP) was the notional incumbent as a result of the redistribution.

```
<Candidate>
  <eml:CandidateIdentifier Id="17921">
    <eml:CandidateName>BARTLETT, Kerry</eml:CandidateName>
  </eml:CandidateIdentifier>
  <eml:AffiliationIdentifier Id="188" ShortCode="LP">
    <eml:RegisteredName>Liberal</eml:RegisteredName>
  </eml:AffiliationIdentifier>
  <BallotPosition>3</BallotPosition>
  <Elected Historic="true">>false</Elected>
  <Incumbent Notional="false">>true</Incumbent>
```

```
<Candidate>
  <eml:CandidateIdentifier Id="18087">
    <eml:CandidateName>DEBUS, Bob</eml:CandidateName>
  </eml:CandidateIdentifier>
  <eml:AffiliationIdentifier Id="194" ShortCode="ALP">
    <eml:RegisteredName>Labor</eml:RegisteredName>
  </eml:AffiliationIdentifier>
  <eml:BallotPosition>5</eml:BallotPosition>
  <Elected Historic="false">false</Elected>
  <Incumbent Notional="true">false</Incumbent>
</Candidate>
```

10. Frequently Asked Questions for 2023 Referendum

10.1 When will the preload messages be made available?

The preload messages for the upcoming 2023 Referendum can be found on the Media Feed Archive FTP site (<ftp://mediafeedarchive.aec.gov.au>) from September 16th onwards.

10.2 Have any changes been made to the Media Feed XML Schema for the Referendum?

No changes to the XML Schema have been made to support the 2023 Referendum. The existing Version 3.0 of the schema will be used.

10.3 What is the event identifier for the 2023 Referendum?

The event identifier is **29581**.

10.4 Is the result message format for a Referendum different to an Election?

Yes, the results message format for a Referendum is different to the Election format. See section [7.1.4.4 Referendum Media Feed Element](#) for more details on the differences.